



Zentrifugalventilatoren



leichte Ausführung mit Gehäuse und Laufrad aus Stahl



Serie C

Serie C und C ... E

- hoher Druck für hohe Förderleistung zur Überwindung von Druckverlusten
- einseitig saugend
- geschlossene Bauart mit dauergeschmierten Kugellagern
- 2- bzw. 4 polige Ausführung, Schutzart IP55
- vorwärtsgekrümmtes Laufrad aus verzinktem Stahlblech, für hohe Luftleistung
- Laufrad direkt auf der Welle des Motors montiert
- Gehäuse aus stabilem Stahlblech mit Epoxydlackierung

Spannung 230 V / 50 Hz

Type		C10/2M	C15/2M	C20/2M E	C25/2M E	C30/2M E	C30/4M E	C35/4M E	C37/4M E	C40/4M E
Art. Nr.		30302	30902	30321	30323	30325	30327	30330	30332	30334
Preis		292,90	323,00	396,20	432,10	545,60	468,00	468,00	811,20	887,30
Fördervolumen	m³/h	300	450	810	955	1.420	700	1.270	2.100	2.700
max. Druck	Pa	245	441	501	584	824	194	325	422	500
Nennstrom	A	0,45	0,70	1,50	1,7	3,20	0,58	1,37	2,7	3,80
Leistungsaufnahme	W	100	160	350	390	740	132	310	600	870
Geräuschpegel (3 m)	dB(A)	55,5	59	66	66,5	71	55	61	70	73
Fördertemp. max	°C	50	50	50	50	50	50	50	50	50
Drehzahl	U/min	2800	2800	2800	2800	2800	1400	1400	1400	1400
Pole		2	2	2	2	2	4	4	4	4
Gewicht	kg	2,7	5	6	6,8	8,4	9	11	20,5	21
I REM INV 4 (12815)		X	X	X	X	X	X	X	X	
I REM INV 6 (12818)										X

Spannung 3 x 230 / 400 V / 50 Hz

Type		C10/2T	C15/2T	C20/2T E	C25/2T E	C30/2T E	C30/4T E	C31/4T E	C35/4T E	C37/4T E	C40/4T E	C45/4T E	C46/4T E
Art. Nr.		30351	30951	30322	30324	30326	30328	30329	30331	30333	30335	30336	30337
Preis		280,00	287,10	370,40	394,80	519,70	425,00	501,10	479,50	808,30	759,50	1.056,70	2.196,60
Fördervolumen	m³/h	270	430	800	970	1.350	655	805	1.550	2.050	2.310	4.500	6.650
max. Druck	Pa	245	422	517	569	834	176	281	334	442	507	726	814
Nennstrom	A	0,30	0,35	0,54	0,63	1,50	0,19	0,28	0,70	1,0	1,2	4,35	5,5
Leistungsaufnahme	W	130	160	330	390	720	110	175	350	600	750	1.900	3.400
Geräuschpegel (3 m)	dB(A)	55,5	59	66	66,5	71	55	61	61	70	73	70,5	76,5
Fördertemp. max	°C	50	50	50	50	50	50	50	50	50	50	50	30
Drehzahl	U/min	2800	2800	2800	2800	2800	1400	1400	1400	1380	1320	1400	1400
Pole		2	2	2	2	2	4	4	4	4	4	4	4
Gewicht	kg	4,6	3,3	5,8	6,3	8,1	8,1	9,5	9,3	20,5	21,5	23,3	61
I RET INV 2.5 (12816)		X	X	X	X	X	X	X	X	X	X	X	
I REM INV 5 (12817)													X

Drehzahlsteller
siehe Seite 208

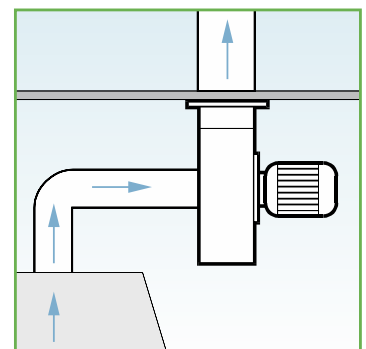
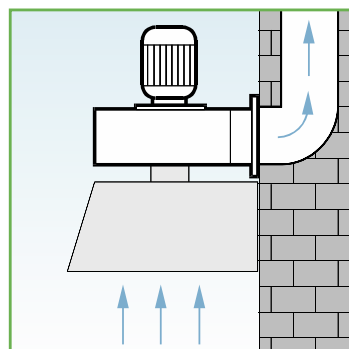
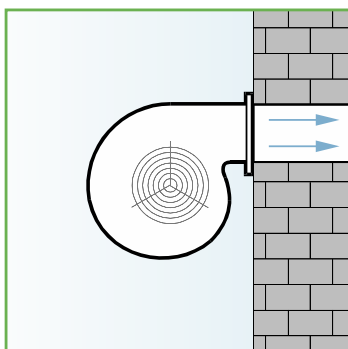

Zentrifugalventilatoren

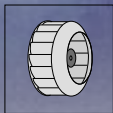

Abmessungen und Zubehör

Abmessungen

	A	B	C	D	E	G	H	I	L	M	P
C 10	171	260	186	72	82	71,6	66,5	81	56	71	36
C 15	206	281	234	108	100	86,6	79	99	56	71	36
C 20	232	350	258	123	123	106	87	117	71	90	45
C 25	232	366	258	124	142	119	87	117	71	90	45
C 30	272	352	308	126	137	122	111	131	71	90	45
C 31	340	351	400	164	139	117	144	152	71	90	45
C 35	340	387	400	164	174	154	144	152	71	90	45
C 37	416,5	435	471	220	182	155	146	181,5	80	100	50
C 40	418	466	472	214	208	191	147	181,5	80	100	50
C 45	485,5	549	557	228	228	208	217	222	90	125	56
C 46*	566	593	675	306	265	236	244,5	250	112	270	27

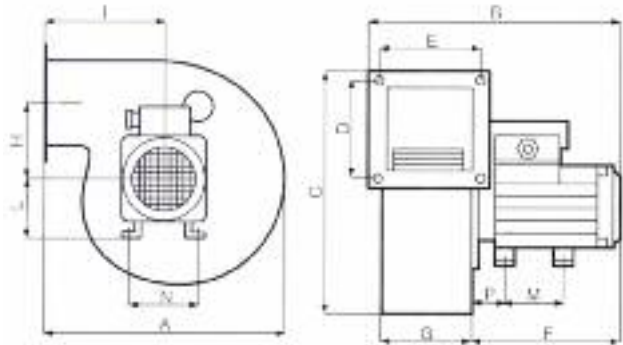

C-RA.. Übergangsflansch für Serie C

	Art. Nr.	Preis	øA	B	øC	øD	E	F	für...
C-RA10	22825	35,90	111,5	100	80	7	83	1	C10
C-RA15	22826	40,20	141	128	108	7	114	1	C15
C-RA20	22827	43,10	152	132	108	7	118	1	C20
C-RA25	22828	43,10	152	132	108	7	116	1	C25
C-RA30	22829	48,80	190	170	132	7	141	1	C30
C-RA31	22830	50,20	240	220	170	8,5	169	1	C31
C-RA35	22831	56,00	240	220	170	8,5	173	1	C35
C-RA37	22832	70,30	282	262	199	8,5	224	1	C37
C-RA40	22833	71,80	282	262	199	8,5	229	1	C40
C-RA45	22834	94,80	320	300	236	8,5	235	1	C45
C-RA46	22835	113,40	420	395	288	8,5	270	2	C46

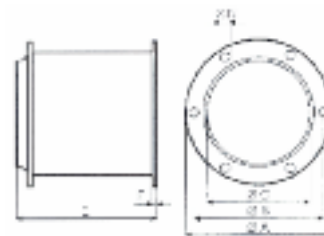

C-RA

C-GM.. Ausblasschutzgitter für Serie C

	Art. Nr.	Preis	A	B	C	D	E	F	øG	für...
C-GM10	22811	17,20	98	82	68	88	72	63	6,5	C10
C-GM15	22812	17,20	125	100	83	132	108	88	7	C15
C-GM20	22813	18,70	145	123	102	145	123	98	8,5	C20
C-GM25	22814	20,10	164	142	115	146	124	98	8,5	C25
C-GM30	22816	21,60	162	137	117	150	126	108	8,5	C30
C-GM31	22817	21,50	165	139	112	190	164	137	8,5	C31
C-GM35	22818	27,30	200	174	149	190	164	137	8,5	C35
C-GM37	22819	30,10	218	182	149	250	220	187	8,5	C37
C-GM40	22820	31,60	244	208	185	250	214	187	8,5	C40
C-GM45	22821	40,20	260	228	200	260	228	200	9	C45
C-GM46	22822	40,20	295	265	236	336	306	277	11,5	C46

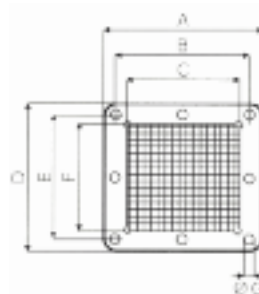

C-GM

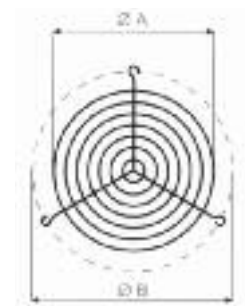

C-GA

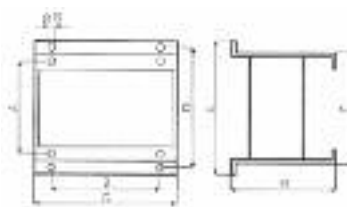

C-MS

C-GA.. Ansaugschutzgitter für Serie C

	Art. Nr.	Preis	øA	øB	n° fix	für..
C-GA10	22801	11,50	80	104	3x120°	C10
C-GA15	22802	12,90	100	134	3x120°	C15
C-GA20/25	22803	14,40	120	142	3x120°	C20/25
C-GA30	22804	14,40	140	176	3x120°	C30
C-GA31/35	22805	15,80	180	220	4x90°	C31/35
C-GA37/40	22806	17,20	220	262	4x90°	C37/40
C-GA45	22807	18,70	260	300	5x72°	C45
C-GA46	22808	23,00	340	395	4x90°	C46

C-MS.. Montagefüsse für Serie C

	Art. Nr.	Preis	A	B	C	D	E	F	øG	H	für...
C-MS20/25	22836	41,60	112	90	120	187	220	152	8	125	C20/25
C-MS30	22837	44,50	112	90	120	187	220	152	8	170	C30
C-MS31/35	22838	51,70	112	90	120	187	220	160	8	200	C31/35
C-MS37/40	22839	58,90	125	100	140	200	235	165	10	230	C37/40
C-MS45	22840	66,00	140	125	175	215	250	180	10	300	C45

* bei Modell C46/4T E ist der Montagefuß im Lieferumfang enthalten

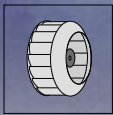

Zentrifugalventilatoren

Leistungsdiagramme für Serie C

Frequenzumformer

IRET.. für 3 x 400 V/50 Hz

	Art. Nr.	Preis	A	B	C
IRET INV2.5	12816	1.173,00	115	284	240
IRET INV5	12817	1.625,00	196	302	250
IRET INV8	12821	1.775,00	196	302	250

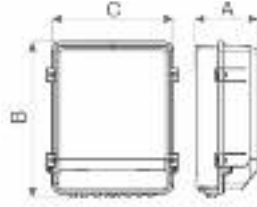

Frequenzumformer

IREM INV für 230 V/50 Hz

	Art. Nr.	Preis	A	B	C
IREM INV4	12815	1.184,00	115	284	240
IREM INV6	12818	1.527,00	195,5	302	250

Potentiometer zu Frequenzumformer

POT zu Serie IRET INV...

	Art. Nr.	Preis (RG: VF)
POT	12828	78,20

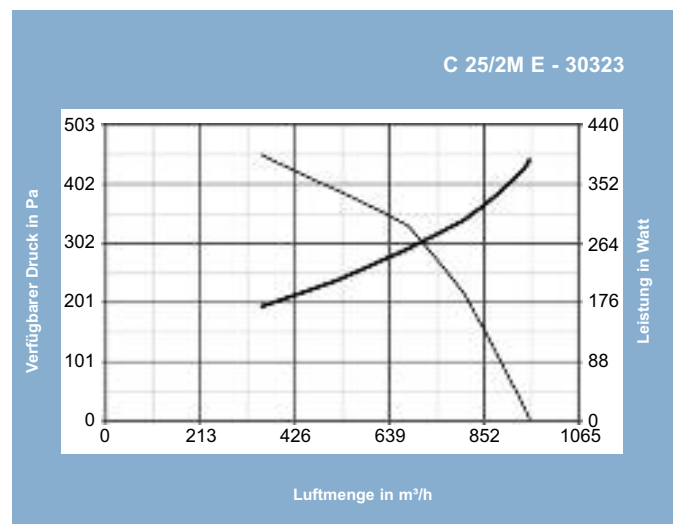
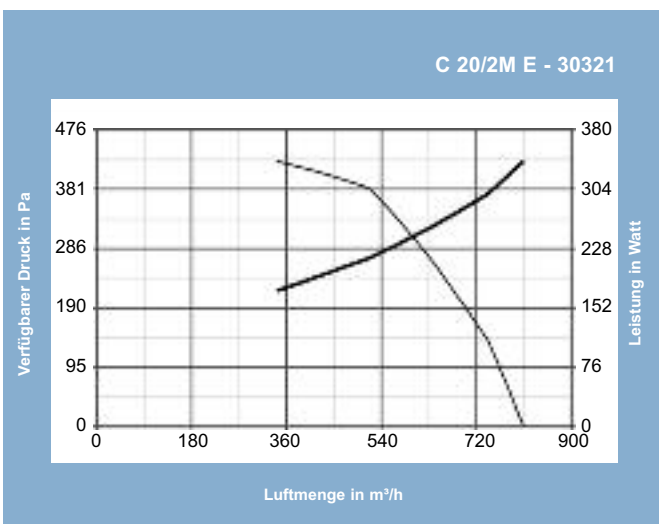
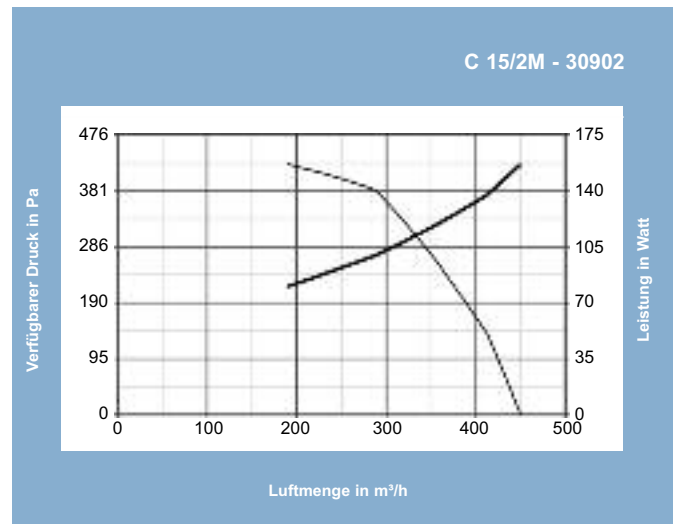
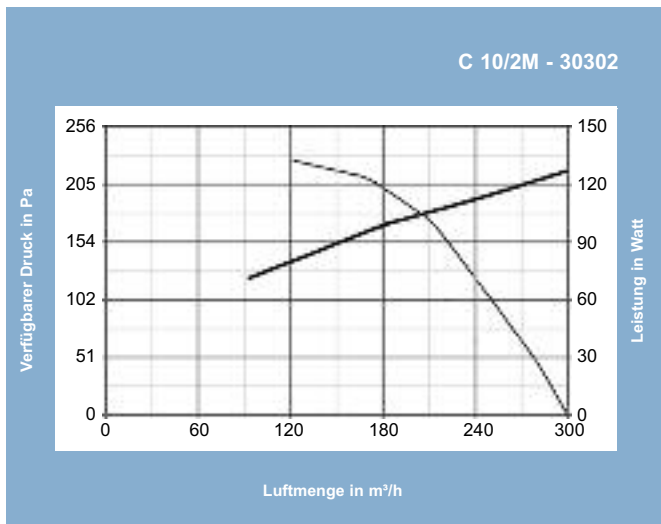
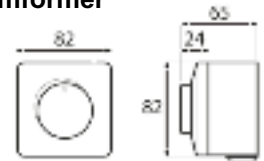

— Luftmenge
 — Leistungsaufnahme

Zentrifugalventilatoren

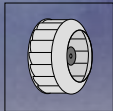

Leistungsdiagramme für Serie C

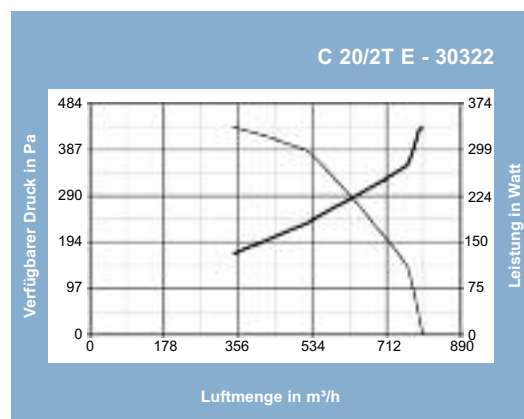
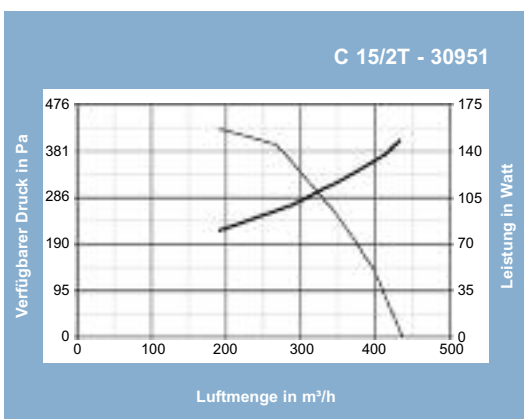
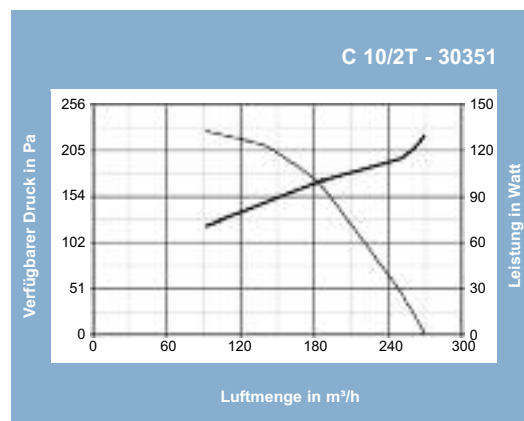
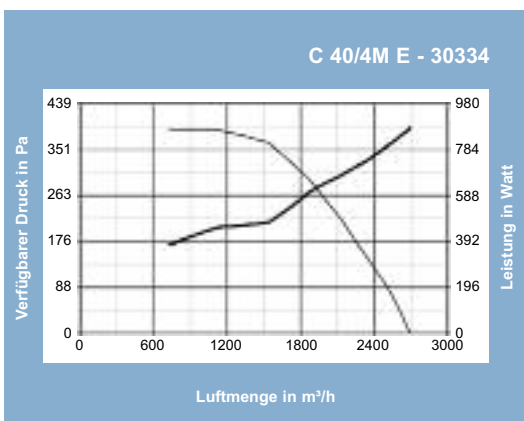
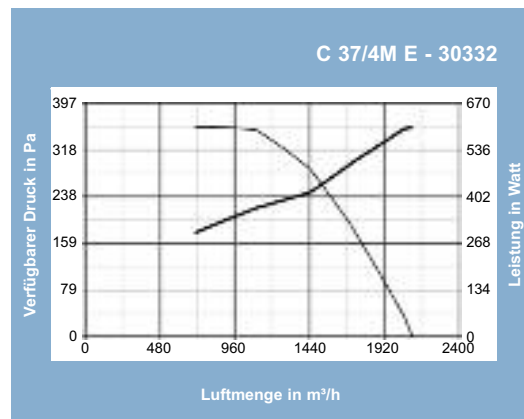
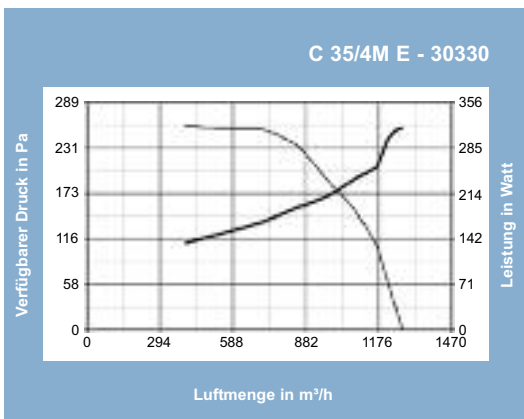
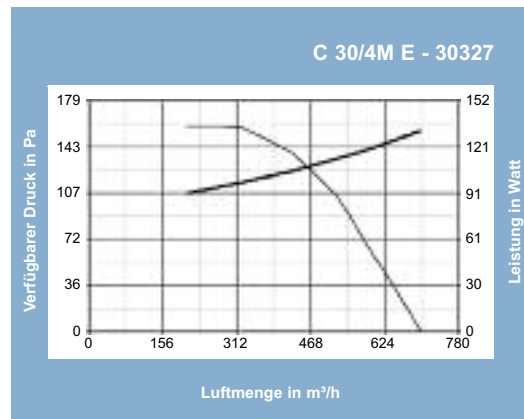
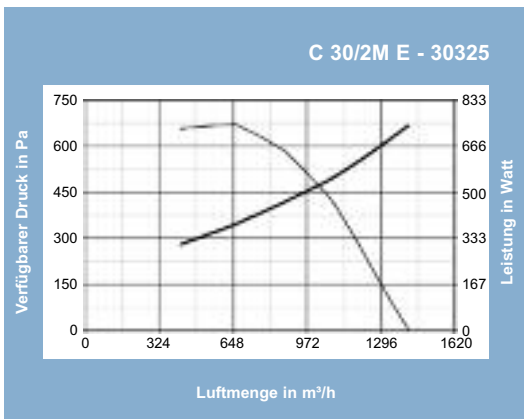

— Luftmenge
— Leistungsaufnahme

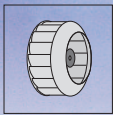

Zentrifugalventilatoren

Leistungsdiagramme für Serie C

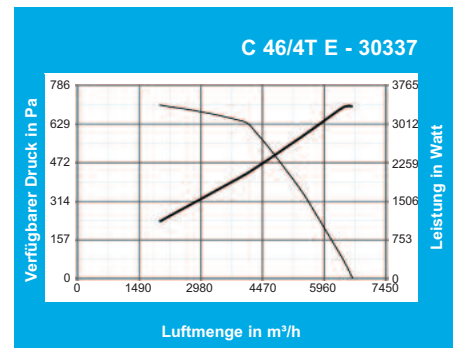
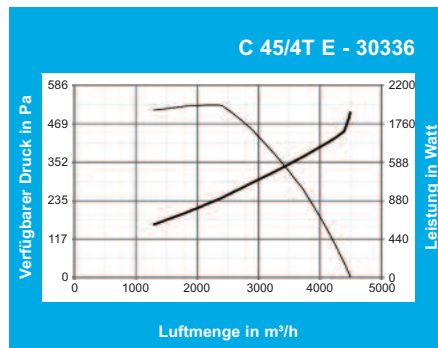
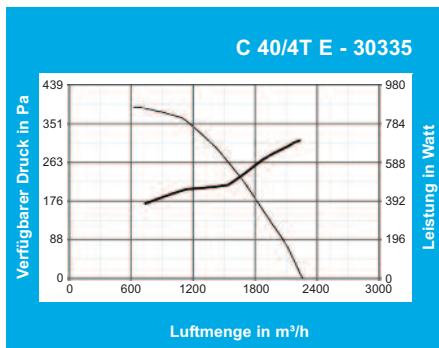
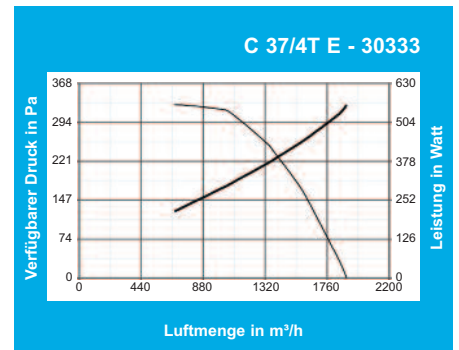
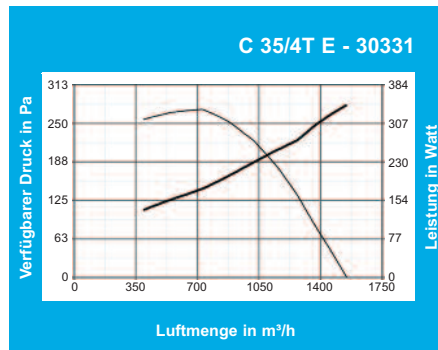
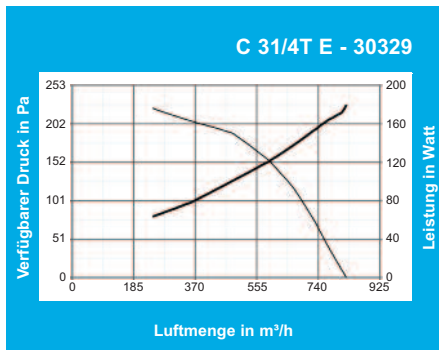
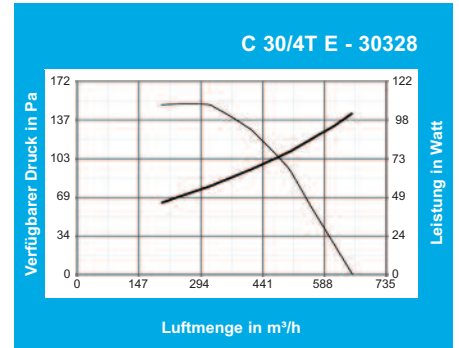
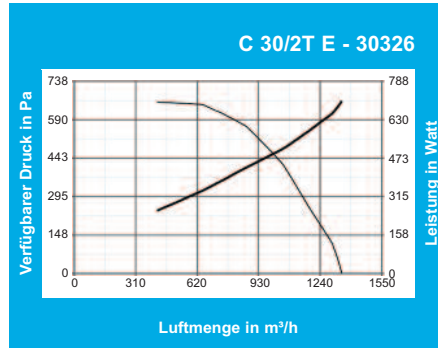
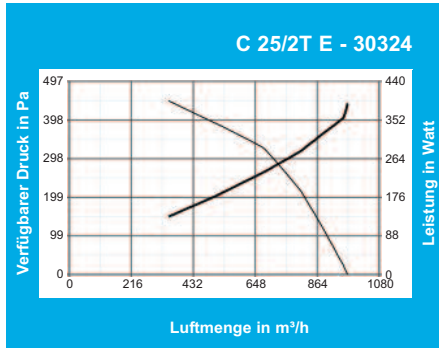

— Luftmenge
 — Leistungsaufnahme