

# Dachventilatoren

Brandgasventilatoren für 400 °C / 120 min



TRM..ED und TRT..ED



TRM..ED-V und TRT..ED-V

## Serie TRM-ED und TRT-ED horizontal oder vertikal ausblasend

- Dauereinsatztemperatur von -25 °C bis +90 °C
- Brandgastemperatur 400 °C für 120 Minuten nach EN12101-3\* (nur auf voller Leistung)
- Gehäuse aus Metall mit Epoxydharzlackierung
- selbstreinigendes Aluminiumlaufrad
- Transportöse zum sicheren Transport an den Montageort
- Einphasenmodelle regelbar über optionalen Drehzahlregler\*\*
- Dreiphasenmodelle schaltbar über optionalen Sterndreieckschalter oder Drehzahlregler\*\*
- zur sicheren Befestigung ist das Gerät mit einem Sicherheitsseil ausgestattet das an der Tragekonstruktion befestigt werden kann.
- nicht geeignet für Montage auf Rohren unmittelbar über offenen Kaminen oder Brennern
- Motorisoliationsklasse H
- Schutzart IP55
- Ausführungsformen:

**TRM..ED und TRT..ED** mit horizontaler Ausblasung

**TRM..ED-V und TRT..ED-V** mit vertikaler Ausblasung

Teuerungszuschlag ab 15. 10. 2022 14,0%

Type TRM ...		10ED 4P	15ED 4P	20ED 4P	30ED 4P	50ED 4P	70ED 4P
Art. Nr.		15039	15041	15043	15046	15048	15080
Preis		575,70	587,20	769,50	834,10	972,00	1.699,90
Type TRM ...		10ED-V 4P	15ED-V 4P	20ED-V 4P	30ED-V 4P	50ED-V 4P	70ED-V 4P
Art. Nr.		15160	15162	15164	15166	15168	15170
Preis		920,30	937,50	1.227,50	1.249,00	1.358,20	2.205,20
Fördermenge	m³/h	1000	1400	2200	3100	4500	5800
max. Druck	Pa	196	235	334	392	510	638
Spannung 50 Hz	V	230	230	230	230	230	230
Nennstrom	A	0,46	0,60	1,20	1,90	3,30	4,5
Leistungsaufnahme	W	110	140	270	420	720	1020
Drehzahl	U/min	1395	1315	1375	1285	1290	1415
Schallpegel (3 m)	dB(A)	56	58,5	68	67	72,5	77

Teuerungszuschlag ab 15. 10. 2022 14,0%

Type TRT ...		10ED 4P	15ED 4P	20ED 4P	30ED 4P	50ED 4P	70ED 4P	70ED 6P
Art. Nr.		15040	15042	15045	15047	15049	15081	15082
Preis		584,30	578,60	722,10	793,90	900,20	1.635,20	1.849,20
Type TRT ...		10ED-V 4P	15ED-V 4P	20ED-V 4P	30ED-V 4P	50ED-V 4P	70ED-V 4P	70ED-V 6P
Art. Nr.		15161	15163	15165	15167	15169	15171	15172
Preis		933,20	924,60	1.190,20	1.228,90	1.302,20	2.121,90	2.400,50
Fördermenge min/max	m³/h	890/1100	1100/1400	1800/2200	2555/3100	3800/4500	5300/6000	5300/6000
Druck min/max	Pa	167/206	157/235	235/334	294/422	373/510	510/657	294/373
Spannung 50 Hz	V	3x 400	3x 400	3x 400	3x 400	3x 400	3x 400	3x 400
Nennstrom min/max	A	0,13/0,24	0,16/0,27	0,32/0,53	0,48/0,75	0,80/1,20	1,50/2,0	0,80/1,30
Leistungsaufn. min/max	W	72/100	93/130	208/270	305/420	530/690	820/1090	420/580
Drehzahl min/max	U/min	1270/1430	1150/1400	1050/1400	1070/1400	1150/1400	1150/1400	750/950
Schallpegel (3 m)	dB(A)	56	58,5	68	67	72,5	77	74

Teuerungszuschlag ab 15. 10. 2022 14,0%

Type TRT		100ED 4P	100ED 6P	100ED 8P	150ED 6P	150ED 8P	180ED 6P	210ED 6P
Art. Nr.		15083	15084	15085	15086	15087	15919	15920
Preis		1.849,20	2.442,10	2.691,90	2.641,70	2.957,50	3.095,30	3.312,10
Type TRT		100ED-V 4P	100ED-V 6P	100ED-V 8P	150ED-V 6P	150ED-V 8P	180ED-V 6P	210ED-V 6P
Art. Nr.		15173	15174	15175	15176	15177	15178	15179
Preis		2.307,10	3.045,10	3.358,10	3.162,80	3.543,30	3.762,90	3.923,70
Fördermenge min/max	m³/h	8300/9100	7550/8600	8200/9200	11000/12800	11600/13500	16500/-	18000/-
Druck min/max	Pa	706/824	373/461	275/334	412/579	334/412	775/-	785/-
Spannung 50 Hz	V	3x 400	3x 400	3x 400	3x 400	3x 400	3x 400	3x 400
Nennstrom min/max	A	2,90/4,90	1,40/2,40	1,20/2,00	2,40/3,50	2,00/3,00	6,11/-	6,42/-
Leistungsaufn. min/max	W	1400/1950	900/1130	600/860	1280/1930	1000/1500	3200/-	3460/-
Drehzahl min/max	U/min	1200/1400	730/950	570/715	700/930	610/715	950/-	950/-
Schallpegel (3 m)	dB(A)	84	77	71	80	74	83	84

# Dachventilatoren

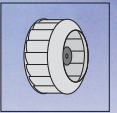

## Abmessungen

### Serie TRM-ED und TRT-ED horizontal ausblasend

#### Abmessungen

Modell	Flügel	ø A	B	C	D	E	F	G	H	ø L	ø M	ø N	Flügel	kg
TRM 10 ED 4P	280x101,5	600	410	357	309	166	38	26,5	513	183	187,5	280	101,5	18,5
TRT 10 ED 4P	280x101,5	600	410	357	309	166	38	26,5	513	183	187,5	280	101,5	18,5
TRM 15 ED 4P	315x101,5	600	410	357	309	166	38	26,5	513	206	211	315	101,5	19
TRT 15 ED 4P	315x101,5	600	410	357	309	166	38	26,5	513	206	211	315	101,5	19
TRM 20 ED 4P	355x125	780	550	500	397	226	38	25	661	231	236,5	355	125	33
TRT 20 ED 4P	355x125	780	550	500	397	226	38	25	661	231	236,5	355	125	33
TRM 30 ED 4P	400x140	780	550	500	397	226	38	25	661	260	265,5	400	140	35
TRT 30 ED 4P	400x140	780	550	500	397	226	38	25	661	260	265,5	400	140	35
TRM 50 ED 4P	450x160	780	550	500	397	243	38	25	678	292	298	450	160	40
TRT 50 ED 4P	450x160	780	550	500	397	243	38	25	678	292	298	450	160	40
TRM 70 ED 4P	500x160	1015	830	750	449	283	38	40	770	328	335	504	160	80
TRT 70 ED 4P	500x160	1015	830	750	449	283	38	40	770	328	335	504	160	78
TRT 70 ED 6P	560x180	1015	830	750	449	283	38	40	770	365	375	562	180	81
TRT 100 ED 4P	560x180	1015	830	750	449	283	38	40	770	365	375	562	180	81,5
TRT 100 ED 6P	630x224	1165	980	900	605	383	38	40	1026	415	421	635	224	114
TRT 100 ED 8P	710x224	1165	980	900	605	383	38	40	1026	415	472	715	224	124
TRT 150 ED 6P	710x250	1165	980	900	605	383	38	40	1026	465	472	715	250	125
TRT 150 ED 8P	800x250	1165	980	900	605	383	38	40	1026	520	529	805	250	129
TRT 180 ED 6P	800x250	1165	980	900	605	383	38	40	1026	520	529	805	250	220
TRT 210 ED 6P	800x250	1165	980	900	605	383	38	40	1026	520	529	805	250	222

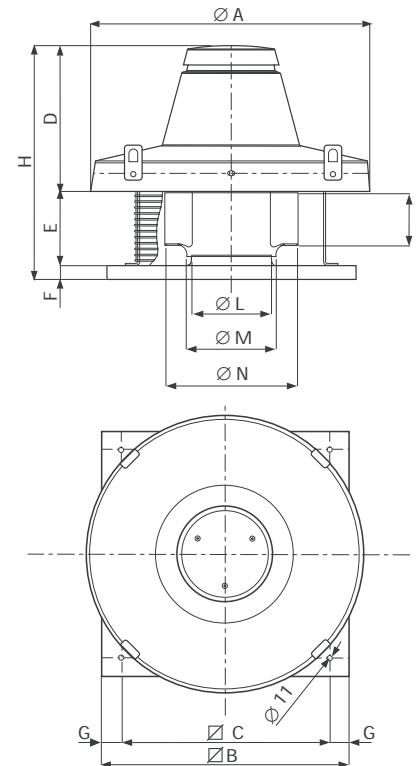

### Serie TRM-ED-V und TRT-ED-V vertikal ausblasend

#### Abmessungen

Modell	ø A	B	C	D	E	F	G	H	ø L	ø M	ø N	kg
TRM 10 ED-V 4P	652	410	357	440	328	38	26,5	502	170	187,5	283	18,5
TRM 15 ED-V 4P	652	410	357	440	328	38	26,5	502	182	199	315	19
TRM 20 ED-V 4P	907	550	500	580	432	38	25	586	219	236,5	359	33
TRM 30 ED-V 4P	907	550	500	580	432	38	25	604	244	265,5	404	35
TRM 50 ED-V 4P	907	550	500	580	432	38	25	631	278	298	454	40
TRM 70 ED 4P	1144	830	750	860	491	38	40	723	328	335	504	80
TRT 10 ED-V 4P	652	410	357	440	328	38	26,5	502	170	187,5	283	18,5
TRT 15 ED-V 4P	652	410	357	440	328	38	26,5	502	182	199	315	19
TRT 20 ED-V 4P	907	550	500	580	432	38	25	586	219	236,5	359	33
TRT 30 ED-V 4P	907	550	500	580	432	38	25	604	244	265,5	404	35
TRT 50 ED-V 4P	907	550	500	580	432	38	25	631	278	298	454	40
TRT 70 ED-V 4P	1144	830	750	860	491	38	40	723	328	335	504	78
TRT 70 ED-V 6P	1144	830	750	860	491	38	40	723	365	375	564	81
TRT 100 ED-V 4P	1144	830	750	860	491	38	40	723	365	375	564	81,5
TRT 100 ED-V 6P	1462	980	900	1010	595	38	40	923	415	421	635	114
TRT 100 ED-V 8P	1462	980	900	1010	595	38	40	923	465	472	715	124
TRT 150 ED-V 6P	1462	980	900	1010	595	38	40	923	465	472	715	125
TRT 150 ED-V 8P	1462	980	900	1010	595	38	40	923	520	529	805	129
TRT 180 ED-V 6P	1462	980	900	1010	595	38	40	923	520	529	805	127
TRT 210 ED-V 6P	1462	980	900	1010	595	38	40	923	520	529	805	129

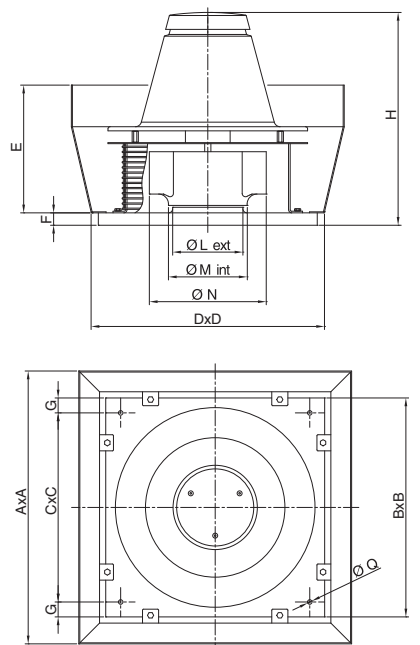

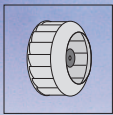

# Dachventilatoren

## Leistungsdiagramme

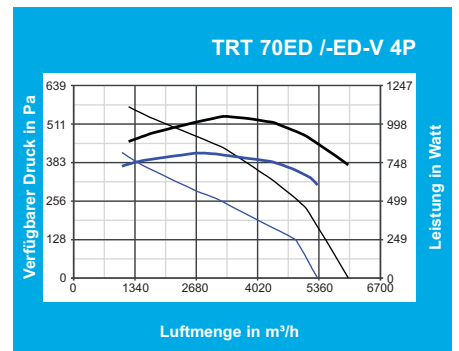
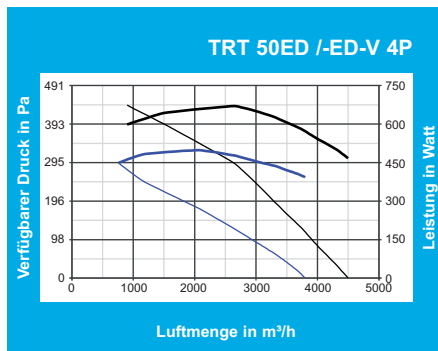
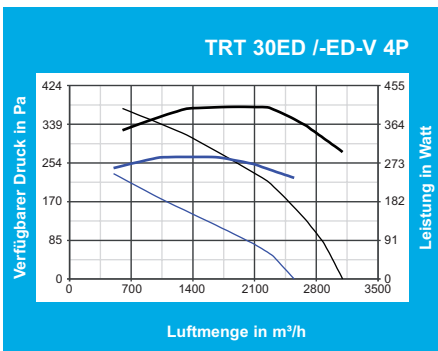
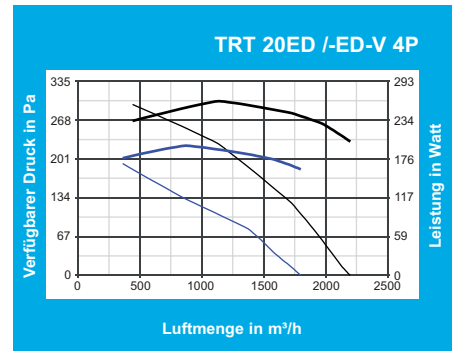
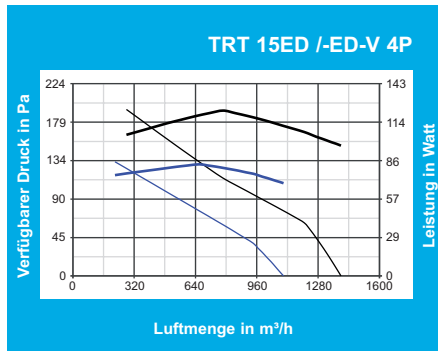
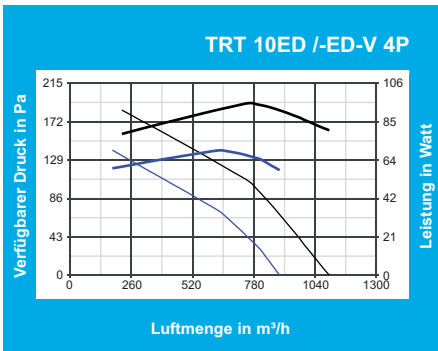
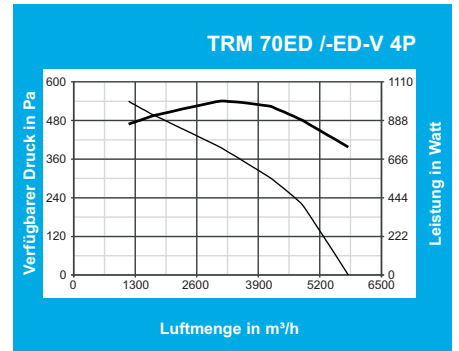
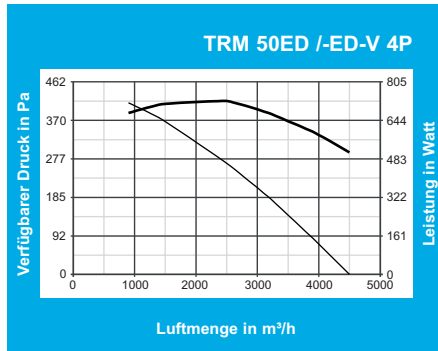
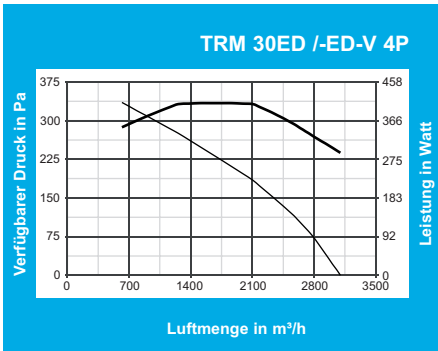
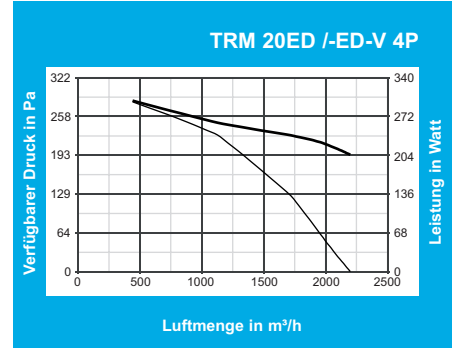
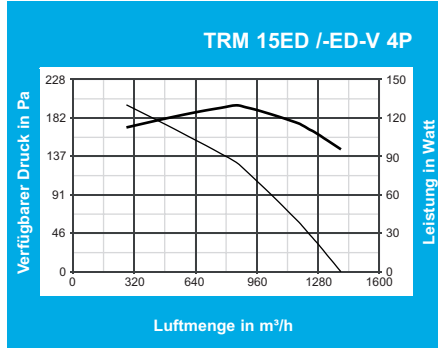
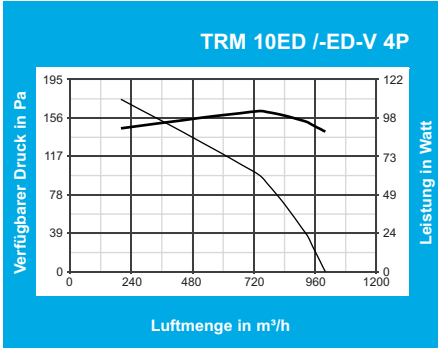

— Luftmenge  
— Leistungsaufnahme

# Dachventilatoren

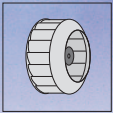

für TRM...ED, TRM...ED-V, TRT...ED und TRT...ED-V

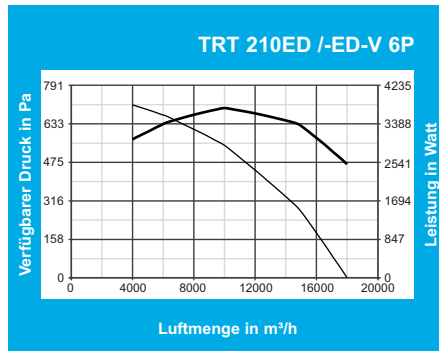
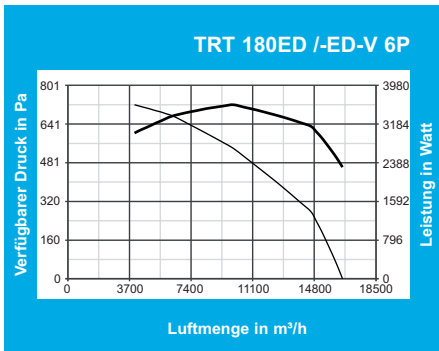
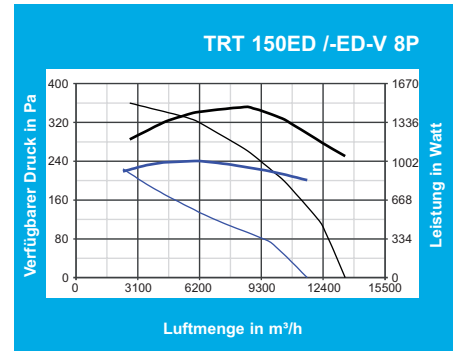
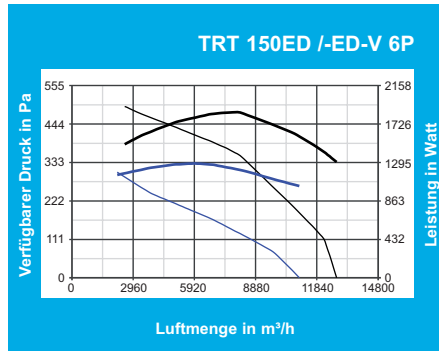
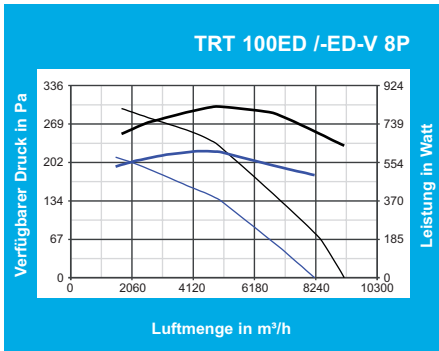
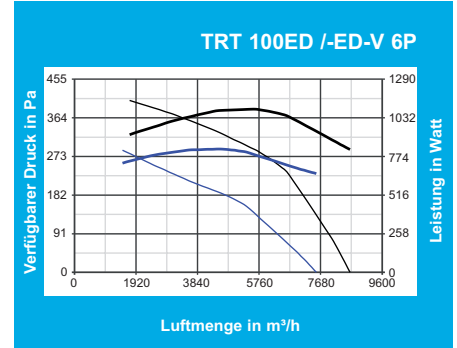
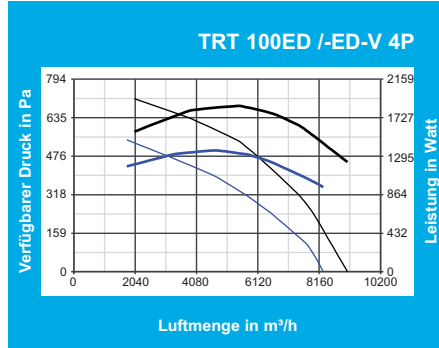
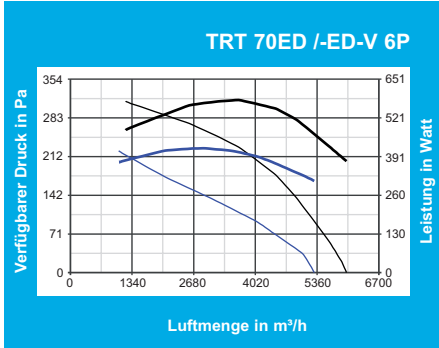

— Luftmenge  
— Leistungsaufnahme

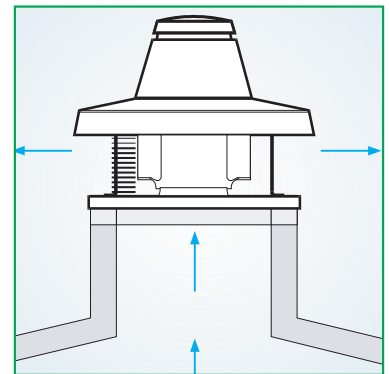
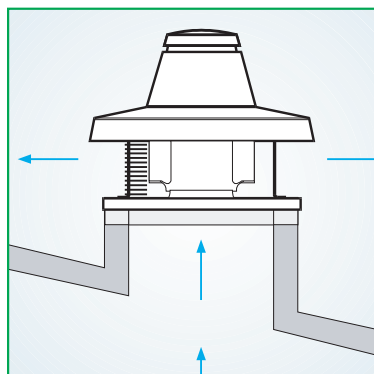
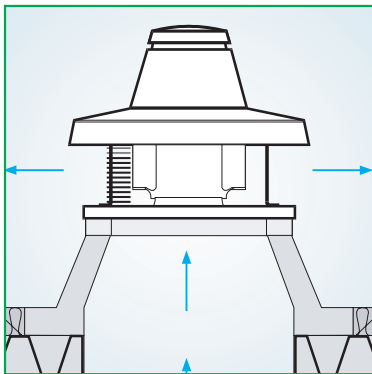

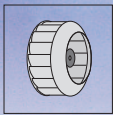







# Dachventilatoren

## Zubehör

für Serie TRM..ED, TRM..ED-V und TRT..ED, TRT..ED-V

Teuerungszuschlag ab 15. 10. 2022 14,0%

Type	TRM 10 ED 4P	TRT 10 ED 4P	TRM 15 ED 4P	TRT 15 ED 4P	TRM 20 ED 4P	TRT 20 ED 4P	TRM 30 ED 4P	TRT 30 ED 4P	TRM 50 ED 4P	TRT 50 ED 4P
 <b>Grundrahmen</b> Art. Nr. Preis	TR-CU 10/15 22511 47,40	TR-CU 10/15 22511 47,40	TR-CU 10/15 22511 47,40	TR-CU 10/15 22511 47,40	TR-CU 20/30/50 22512 51,70	TR-CU 20/30/50 22512 51,70	TR-CU 20/30/50 22512 51,70	TR-CU 20/30/50 22512 51,70	TR-CU 20/30/50 22512 51,70	TR-CU 20/30/50 22512 51,70
 <b>Schutzgitter saugseitig</b> Art. Nr. Preis	TR-ED G 10/15 22700 14,40	TR-ED G 10/15 22700 14,40	TR-ED G 10/15 22700 14,40	TR-ED G 10/15 22700 14,40	TR-ED G 20/30/50 22710 20,10	TR-ED G 20/30/50 22710 20,10	TR-ED G 20/30/50 22710 20,10	TR-ED G 20/30/50 22710 20,10	TR-ED G 20/30/50 22710 20,10	TR-ED G 20/30/50 22710 20,10
 <b>2-Stufen Schalter</b> Art. Nr. Preis	- - -	TR-CVT 22910 201,00	- - -	TR-CVT 22910 201,00	- - -	TR-CVT 22910 201,00	- - -	TR-CVT 22910 201,00	- - -	TR-CVT 22910 201,00
 <b>Drehzahlregler 3-stufig 1-phasig, 230 V / 50 Hz</b> Art. Nr. Preis	IRM30 12921 201,00	- - -	IRM30 12921 201,00	- - -	IRM40 12922 211,00	- - -	IRM40 12922 211,00	- - -	IRM50 12928 225,40	- - -
 <b>Drehzahlregler 3-stufig 3-phasig, 3x400 V / 50 Hz</b> Art. Nr. Preis	- - -	IRT15 12923 244,10	- - -	IRT15 12923 244,10	- - -	IRT15 12923 244,10	- - -	IRT35 12924 282,80	- - -	IRT35 12924 282,80
 <b>Drehzahlsteller 230 V elektronisch stufenlos</b> Art. Nr. Preis	IREM3 12931 196,70	- - -	IREM3 12931 196,70	- - -	IREM3 12931 196,70	- - -	IREM3 12931 196,70	- - -	IREM5 12932 239,80	- - -
 <b>Frequenzumformer 3-phasig, 3x400 V / 50 Hz</b> Art. Nr. Preis	- - -	IRET INV2.5 12816 1.173,00	- - -	IRET INV2.5 12816 1.173,00	- - -	IRET INV2.5 12816 1.173,00	- - -	IRET INV2.5 12816 1.173,00	- - -	IRET INV2.5 12816 1.173,00

## Zubehör für TR

### Grundrahmen für TR.. und TR..ED

	Art. Nr.	Preis	A	B
TR-CU 10/15	22511	47,40	357	401
TR-CU20/30/50	22512	51,70	500	541
TR-CU70/100	22539	57,40	750	791
TR-CU100/150	22540	63,20	900	941

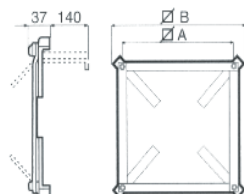

Teuerungszuschlag ab 15. 10. 2022 14,0%

### 2-stufen Drehzahlregler für TR.. und TR..ED

	Art. Nr.	Preis	A	Pos.	IP
TR-CVT	22910	201,00	92	0 <sup>^</sup> Δ	65

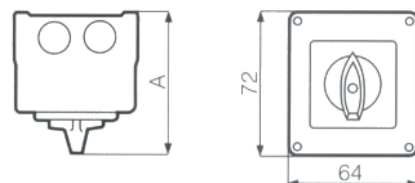

### Schutzgitter für TR.. und TR..ED

Saugseitig

	Art. Nr.	Preis	ØA	ØB
TR-G10/15	22700	14,40	222	254
TR-G20/30/50	22710	20,10	318	359
TR-G70/100	22506	51,70	423	500
TR-G100/150	22507	64,60	563	640

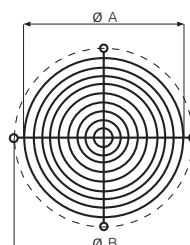

# Dachventilatoren

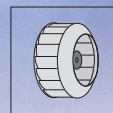

## Zubehör

für Serie TRM..ED, TRM..ED-V und TRT..ED, TRT..ED-V

Teuerungszuschlag ab 15. 10. 2022 14,0%

Type	TRM 70 ED 4P	TRT 70 ED 4P	TRT 70 ED 6P	TRT 100 ED 4P	TRT 100 ED 6P	TRT 100 ED 8P	TRT 150 ED 6P	TRT 150 ED 8P	TRT 180 ED 6P	TRT 210 ED 6P
<b>Grundrahmen</b> Art. Nr. Preis	TR-CU 70/100 22539 57,40	TR-CU 70/100 22539 57,40	TR-CU 70/100 22539 57,40	TR-CU 70/100 22539 57,40	TR-CU 100/150 22540 63,20	TR-CU 100/150 22540 63,20	TR-CU 100/150 22540 63,20	TR-CU 100/150 22540 63,20	TR-CU 100/150 22540 63,20	TR-CU 100/150 22540 63,20
<b>Schutzgitter saugseitig</b> Art. Nr. Preis	TR-ED G 70/100 22506 51,70	TR-ED G 70/100 22506 51,70	TR-ED G 70/100 22506 51,70	TR-ED G 70/100 22506 51,70	TR-ED G 100/150 22507 64,60	TR-ED G 100/150 22507 64,60	TR-ED G 100/150 22507 64,60	TR-ED G 100/150 22507 64,60	TR-ED G 100/150 22507 64,60	TR-ED G 100/150 22507 64,60
<b>2-Stufen Schalter</b> Art. Nr. Preis	- - -	TR-CVT 22910 201,00	TR-CVT 22910 201,00	TR-CVT 22910 201,00	TR-CVT 22910 201,00	TR-CVT 22910 201,00	TR-CVT 22910 201,00	TR-CVT 22910 201,00	TR-CVT 22910 201,00	TR-CVT 22910 201,00
<b>Drehzahlregler 3-stufig 1-phasig, 230 V / 50 Hz</b> Art. Nr. Preis	- - -	- - -	- - -	- - -	- - -	- - -	- - -	- - -	- - -	- - -
<b>Drehzahlregler 3-stufig 3-phasig, 3x400 V / 50 Hz</b> Art. Nr. Preis	- - -	IRT40 12927 387,60	IRT35 12924 282,80	IRT40 12927 387,60	IRT40 12927 387,60	IRT35 12924 282,80	- - -	IRT40 12927 387,60	- - -	- - -
<b>Drehzahlsteller 230 V elektronisch stufenlos</b> Art. Nr. Preis	IREM9 12933 336,00	IRET6 12934 704,90	IRET6 12934 704,90	IRET6 12934 704,90	IRET6 12934 704,90	IRET6 12934 704,90	IRET6 12934 704,90	IRET6 12934 704,90	- - -	- - -
<b>Frequenzumformer 3-phasig, 3x400 V / 50 Hz</b> Art. Nr. Preis	- - -	IRET INV2.5 12816 1.173,00	IRET INV2.5 12816 1.173,00	IRET INV5 12817 1.625,20	IRET INV5 12817 1.625,20	IRET INV2.5 12816 1.173,00	IRET INV5 12817 1.625,20	IRET INV5 12817 1.625,20	IRET INV5 12817 1.625,20	IRET INV8 12821 1.775,90

### Drehzahlregler stufenlos

IREM. für 230 V/50 Hz, IRET. für 3 x 400 V/50 Hz

	Art. Nr.	Preis	A	B	C	D	E
IREM 3	12931	196,70	125	57	31	25	88
IREM 5	12932	239,80	125	57	31	25	88
IREM 9	12933	336,00	125	72	31	25	103
IRET 6	12934	704,90	175	78	27	30	108

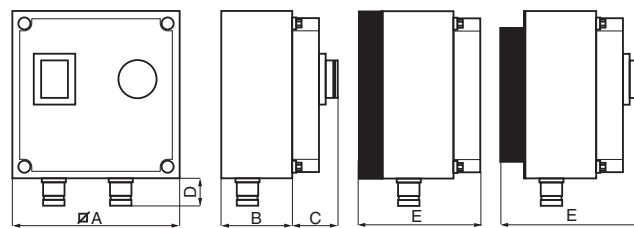

Teuerungszuschlag ab 15. 10. 2022 14,0%

### Drehzahlregler 3-stufig

IRM.. für 230 V/50 Hz, IRT.. für 3 x 400 V/50 Hz

	Art. Nr.	Preis	A	B	C	D
IRM 30	12921	201,00	200	254	99	128
IRM 40	12922	211,00	236	315	128	157
IRM 50	12928	225,40	236	315	128	157
IRT 15	12923	244,10	236	315	128	157
IRT 35	12924	282,80	236	315	128	157
IRT 40	12927	387,60	236	315	128	157

### Frequenzumformer

IRET.. für 3 x 400 V/50 Hz

	Art. Nr.	Preis	A	B	C
IRET INV2.5	12816	1.173,00	115	284	240
IRET INV5	12817	1.625,20	196	302	250
IRET INV8	12821	1.775,90	196	302	250

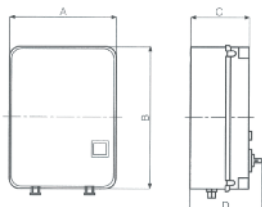

Teuerungszuschlag ab 15. 10. 2022 14,0%

