

Dachventilatoren

für Umgebungstemperaturen von -25 °C bis +55 °C

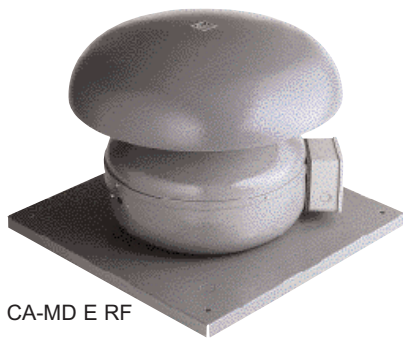

CA-MD E RF

Serie CA-MD E RF mit 3 Drehzahlen

- Gehäuse aus Stahlblech mit Epoxydharzlackierung
- Regenhaube aus Kunststoff
- Motor mit Kugellagern und thermischen Überlastungsschutz
- hervorragend stufenlos drehzahlregelbar
- rückwärts gekrümmtes Radiallaufrad
- 8 verschiedene Baugrößen von DN 100 bis 315
- ideal für die Entlüftung von Bädern, WC-Anlagen sowie für Anlagen der Luft-/Klima- und Kältetechnik

Type CA..		100 MD E RF	125 MD E RF	150Q MD E RF	150 MD E RF	160 MD E RF	200 MD E RF	250 MD E RF	315 MD E RF
Art.Nr.		16140	16141	16142	16183	16184	16185	16186	16187
Preis		278,70	295,70	312,70	411,20	411,20	435,00	514,90	637,30
Fördervolumen	m³/h	95/167/265	118/200/312	122/207/312	230/310/490	245/325/500	310/395/700	385/570/850	370/565/865
Druck	Pa	272/389/161	161/340/345	70/212/307	307/404/432	201/322/400	313/405/440	374/521/552	368/542/573
Nennspannung	V/Ph/Hz	230/1/50	230/1/50	230/1/50	230/1/50	230/1/50	230/1/50	230/1/50	230/1/50
Nennstrom	A	0,13/0,23	0,13/0,23	0,13/0,23	0,33/0,39	0,33/0,39	0,33/0,39	0,47/0,57	0,48/0,57
Leistungsaufnahme	W	12/24/50	12/24/50	12/24/50	33/45/95	33/45/88	33/45/95	48/80/130	48/80/130
Schallpegel (3 m)	dB(A)	27,3/37,5	21,5/40,2	23,8/37,5	24,6/43,8	30,4/44,8	23,0/31,7	28,6/43,8	32,8/40,7
max. Fördertemp.	°C	50	50	50	55	55	55	50	50
Gewicht	kg	4,6	4,6	7,5	7,9	9,0	9,6	10	11
Schutzklasse		IP45	IP45	IP45	IP44	IP44	IP44	IP44	IP44

Abmessungen

	A	B	C	ø D	E	F	ø G	H	L	M	ø N	O
CA 100 MD E RF	334	334	305	97	280	280	9	20	15	35	300	198
CA 125 MD E RF	334	334	305	122	280	280	9	20	23	35	300	198
CA 150Q MD E RF	334	334	305	147	280	280	9	20	30	35	300	198
CA 150 MD E RF	424	424	365	147	370	370	9	20	17	47	400	220
CA 160 MD E RF	424	424	365	157	370	370	9	20	18	47	400	250
CA 200 MD E RF	424	424	365	197	370	370	9	20	20	49	400	250
CA 250 MD E RF	489	489	367	247	435	435	9	20	38	41	400	220
CA 315 MD E RF	489	489	415	312	435	435	9	20	36	65	534	250

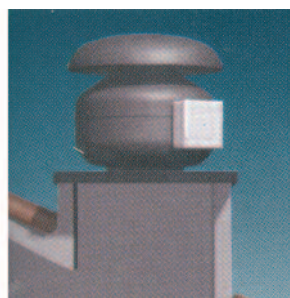
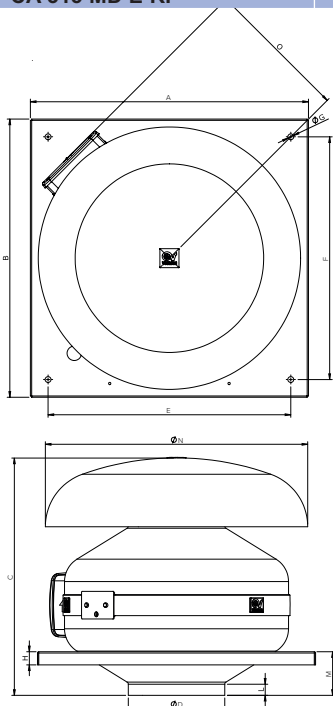

CA-MD E RF auf bauseitigem Sockel



CA-MD E RF mit saugseitigem Schutzgitter



CA-MD E RF mit angebr. Rückschlagklappe

Dachventilatoren



Diagramme und Zubehör



Luftmenge
 — Hohe Stufe
 — Mittlere Stufe
 — Niedrige Stufe

Leistungsaufnahme
 — Hohe Stufe
 — Mittlere Stufe
 — Niedrige Stufe

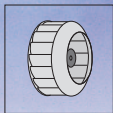
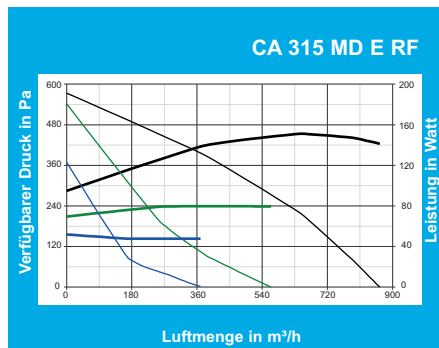
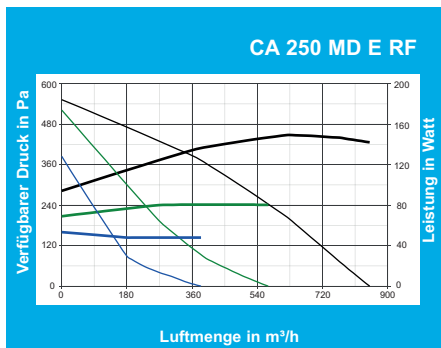
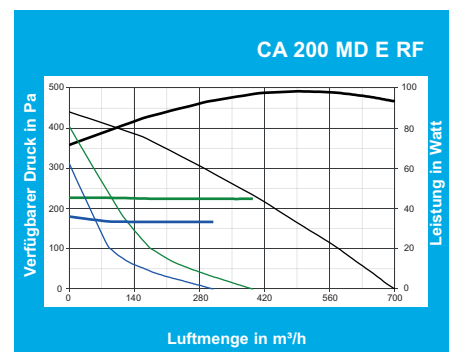
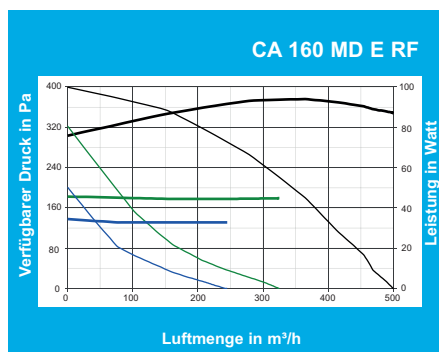
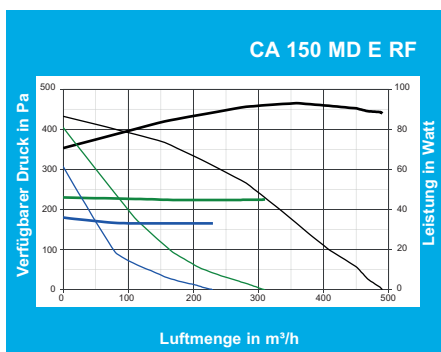
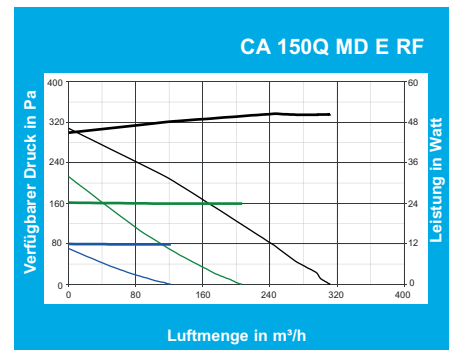
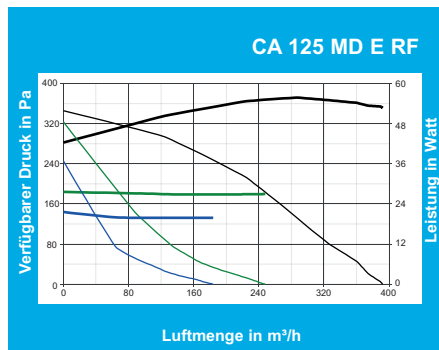
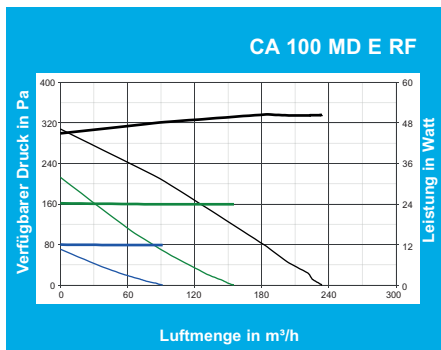
Zubehör

Type Art. Nr.	CA100... 16140	CA125... 1614	CA150Q... 16142	CA150... 16183	CA160... 16184	CA200... 16185	CA250... 16186	CA315... 16187
Befestigungsschellen Art. Nr. 111 ... Preis	DMK100 442 100 7,20	DMK125 442 125 8,30	DMK150 442 150 8,80	DMK150 442 150 8,80	DMK160 442 160 9,20	DMK200 442 200 10,50	DMK250 442 250 11,90	DMK315 442 315 14,70
Rückschlagklappe Art. Nr. Preis	LINEO-S100 22551 37,40	LINEO-S125 22556 42,50	LINEO-S150 22562 44,20	LINEO-S150 22562 44,20	LINEO-S160 22563 49,30	LINEO-S200 22566 56,10	LINEO-S250 22571 71,40	LINEO-S315 22576 79,90
Schutzgitter saugseitig Art. Nr. Preis	CA-G100 22750 11,90	CA-G125 22755 11,90	CA-G150 22760 13,60	CA-G150 22760 13,60	CA-G160 22762 13,60	CA-G200 22765 13,60	CA-G250 22770 17,00	CA-G315 22775 17,00
elektr. Drehzahlregler Art. Nr. Preis	C1.5 12966 62,90	C1.5 12966 62,90	C1.5 12966 62,90	C1.5 12966 62,90	C1.5 12966 62,90	C1.5 12966 62,90	C2.5 12967 78,20	C2.5 12967 78,20
Unterputzkit für SCNR Art. Nr. Preis	SCB Kit 22481 8,50	SCB Kit 22481 8,50	SCB Kit 22481 8,50	SCB Kit 22481 8,50	SCB Kit 22481 8,50	SCB Kit 22481 8,50	SCB Kit 22481 8,50	SCB Kit 22481 8,50