

Dachventilatoren

Serie RF-EU



RF-EU

Serie RF-EU horizontal ausblasend

- Gehäuse aus Metall mit Epoxydharzlackierung
- rückwärtsgekrümmtes Laufrad
- Transportöse zum sicheren Transport an den Montageort
- regelbar über optionalen Drehzahlregler
- zur sicheren Befestigung ist das Gerät mit einem Sicherheitsseil ausgestattet, das an der Tragekonstruktion befestigt werden kann.
- Motorisolutionsklasse F

Spannung 230 / 50 Hz

Type RF-EU ...		M15 4P	M20 4P	M30 4P	M70 4P
Art. Nr.		15121	15122	15123	15125
Preis		983,40	1.035,10	1.201,70	2.132,00
Fördermenge	m³/h	1440	2150	4000	6700
max. Druck	Pa	223	281	428	435
Spannung 50 Hz	V	230	230	230	230
Nennstrom	A	0,56	0,66	2,33	4,42
Leistungsaufnahme	W	118	150	500	906
Drehzahl	U/min	1400	1395	1370	1310
Schallpegel (3 m)	dB(A)	28,3	34,1	43,6	47,2
Temperaturbereich	°C	-30 / +40	-30 / +40	-20 / +40	-20 / +40
Schutzart		IP24	IP24	IP24	IP24

Spannung 3 x 400 V / 50 Hz

Type RF-EU ...		T10 4P	T15 4P	T20 4P	T30 4P	T50 4P	T70 4P
Art. Nr.		15126	15127	15128	15129	15130	15131
Preis		849,90	870,00	1.098,30	1.305,00	1.368,20	1.620,90
Fördermenge	m³/h	1350	1810	2980	4100	5100	5850
max. Druck	Pa	203	254	365	538	648	649
Spannung 50 Hz	V	3x 400	3x 400	3x 400	3x 400	3x 400	3x 400
Nennstrom	A	0,21	0,28	0,49	1,04	1,44	1,63
Leistungsaufnahme	W	93	137	258	523	700	853
Drehzahl	U/min	1367	1387	1395	1400	1400	1370
Schallpegel (3 m)	dB(A)	30,5	37,7	36,6	38,7	50,3	49,1
Temperaturbereich	°C	-15 / +40	-20 / +40	-15 / +40	-20 / +40	-20 / +40	-20 / +40
Schutzart		IP24	IP24	IP24	IP24	IP24	IP24

Spannung 3 x 400 V / 50 Hz

Type RF-EU ...		T70 6P	T100 4P	T100 6P	T100 8P	T150 6P
Art. Nr.		15132	15133	15134	15135	15136
Preis		2.175,10	2.651,70	2.735,00	3.741,40	3.692,60
Fördermenge	m³/h	8100	13100	12000	11000	14500
max. Druck	Pa	399	961	508	303	549
Spannung 50 Hz	V	3x 400	3x 400	3x 400	3x 400	3x 400
Nennstrom	A	1,57	4,92	2,60	1,85	3,85
Leistungsaufnahme	W	721	2700	1210	830	1990
Drehzahl	U/min	900	1430	910	650	890
Schallpegel (3 m)	dB(A)	43,8	58,3	46,9	43,5	46,1
Temperaturbereich	°C	-15 / +40	-20 / +40	-15 / +40	-20 / +40	-20 / +40
Schutzart		IP24	IP24	IP24	IP24	IP24

Dachventilatoren

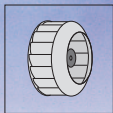

Abmessungen

Abmessungen

Modell	ø A	□ B	□ C	D	E	F	øG	H	kg
RF EU M15 4P	540	410	357	11	255	293	235	69	14,8
RF EU M20 4P	540	410	357	11	281	320	261	69	15,5
RF EU M30 4P	720	550	500	11	358	397	325	76	29,1
RF EU M70 4P	720	550	500	11	455	506	410	76	32
RF EU T10 4P	540	410	357	11	256	295	235	69	15
RF EU T15 4P	540	410	357	11	282	321	255	69	16,2
RF EU T20 4P	720	550	500	11	327	366	292	69	26,3
RF EU T30 4P	720	550	500	11	328	366	325	69	29,3
RF EU T50 4P	720	550	500	11	330	369	362	69	32,2
RF EU T70 4P	720	550	500	11	366	405	362	69	33
RF EU T70 6P	945	900	750	11	497	548	460	21	57
RF EU T100 4P	945	900	750	11	490	540	456	21	60
RF EU T100 6P	945	900	750	11	535	586	510	21	66
RF EU T100 8P	945	900	750	11	595	646	576	21	81
RF EU T150 6P	945	900	750	11	595	646	576	21	81

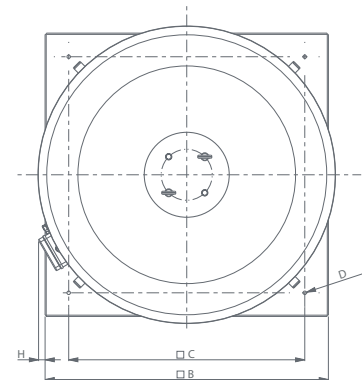
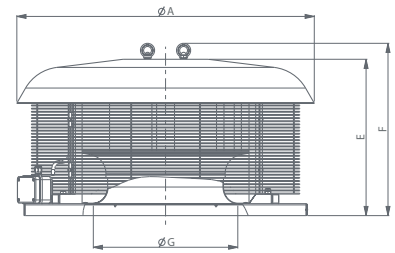

für Type RF-EU

Type	T 10 4P	M / T 15 4P	M 20 4P	T 20 4P	M / T 30 4P	T 50 4P	M / T 70 4P	T 70 6P	T 100 4P	T 100 6P	T 100 8P	T 150 6P	
Grundrahmen Art. Nr. Preis	TR-CU 10/15 22511 47,40	TR-CU 10/15 22511 47,40	TR-CU 10/15 22511 47,40	TR-CU 20/30/50 22512 51,70	TR-CU 20/30/50 22512 51,70	TR-CU 20/30/50 22512 51,70	TR-CU 20/30/50 22512 51,70	TR-CU 70/100 22539 57,40	TR-CU 70/100 22539 57,40	TR-CU 70/100 22539 57,40	TR-CU 70/100 22539 57,40	TR-CU 70/100 22539 57,40	
Schutzgitter saugseitig Art. Nr. Preis	TR-G 20/30/50 22710 20,10	TR-G 20/30/50 22710 20,10	TR-G 20/30/50 22710 20,10	TR-G 70/100/4P 22506 51,70	TR-G 70/100/4P 22506 51,70	TR-G 70/100/4P 22506 51,70	TR-G 70/100/4P 22506 51,70	TR-G 1006P-8P/150/180/210 22507 64,60					
Rückschlagklappe Art. Nr. Preis	TR-S 20/30/50 22510 99,10	TR-S 20/30/50 22510 99,10	TR-S 20/30/50 22510 99,10	TR-S 70/100 22541 310,10	TR-S 70/100 22541 310,10	TR-S 70/100 22541 310,10	TR-S 70/100 22541 310,10	TR-S 100/150 22542 456,50	TR-S 100/150 22542 456,50	TR-S 100/150 22542 456,50	TR-S 100/150 22542 456,60	TR-S 100/150 22542 456,60	
Ansaugdüse Art. Nr. Preis	TR-B 10/15 22610 47,40	TR-B 10/15 22610 47,40	TR-B 10/15 22610 47,40	TR-B 70/100/4P 22508 188,10	TR-B 70/100/4P 22508 188,10	TR-B 70/100/4P 22508 188,10	TR-B 70/100/4P 22508 188,10	TR-B 1006P-8P/150/180/210 22509 213,90					
Drehzahlregler 3-stufig 1-phasig, 230 V/50 Hz Art. Nr. Preis	IRM30 12921 201,00	IRM30 12921 201,00	IRM30 12921 201,00	- - -	IRM40 12922 211,00	- - -	IRM40 12922 211,00	- - -	- - -	- - -	- - -	- - -	- - -
Drehzahlregler 3-stufig 3-phasig, 3x400 V/50 Hz Art. Nr. Preis	IRT15 12923 244,10	IRT15 12923 244,10	- -	IRT15 12923 244,10	IRT35 12924 282,80	IRT35 12924 282,80	IRT35 12924 282,80	IRT35 12924 282,80	- -	IRT40 12927 387,60	IRT35 12924 282,80	IRT40 12927 387,60	
Drehzahlsteller 230V elektronisch stufenlos Art. Nr. Preis	IREM3 12931 196,70	IREM3 12931 196,70	IREM3 12931 196,70	- -	IREM3 12931 196,70	- -	- -	- -	- -	- -	- -	- -	
Frequenzumformer 3-phasig, 3x400 V/50 Hz Art. Nr. Preis	IRET INV2.5M 12816 1.173,00	IRET INV2.5M 12816 1.173,00	- -	IRET INV2.5M 12816 1.173,00	IRET INV2.5M 12816 1.173,00	IRET INV2.5M 12816 1.173,00	IRET INV2.5M 12816 1.173,00	IRET INV2.5M 12816 1.173,00	IRET INV2.5M 12816 1.625,20	IRET INV2.5M 12816 1.173,00	IRET INV2.5M 12816 1.173,00	IRET INV2.5M 12816 1.625,20	
Potentiometer für IRET-INV Art. Nr. Preis	POT INV 12819 99,10	POT INV 12819 99,10	- -	POT INV 12819 99,10	POT INV 12819 99,10	POT INV 12819 99,10	POT INV 12819 99,10	POT INV 12819 99,10	POT INV 12819 99,10	POT INV 12819 99,10	POT INV 12819 99,10	POT INV 12819 99,10	

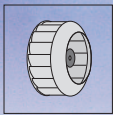

Dachventilatoren

Leistungsdiagramme RF-EU

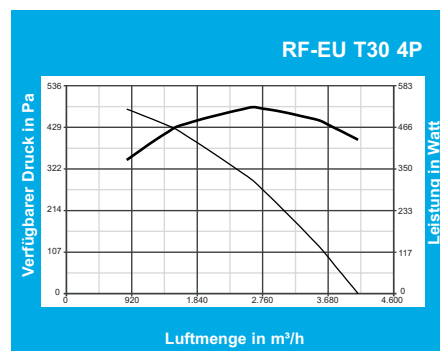
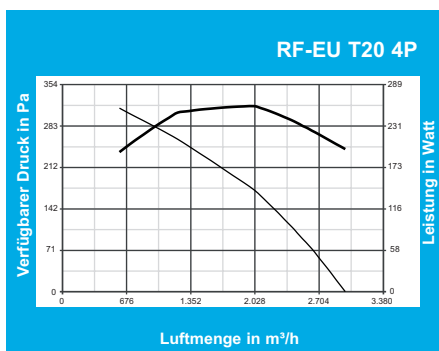
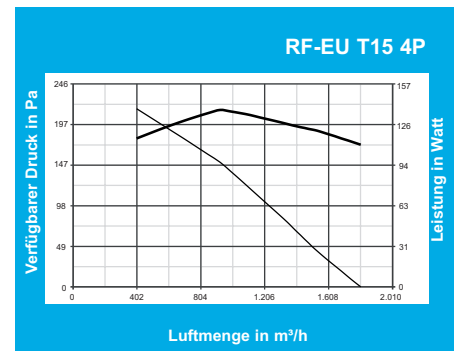
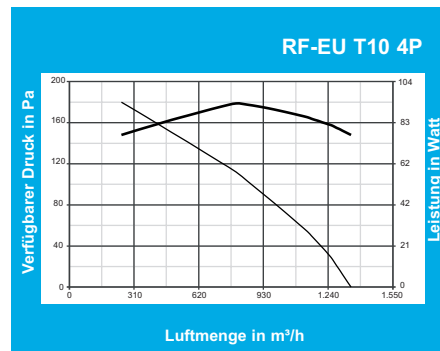
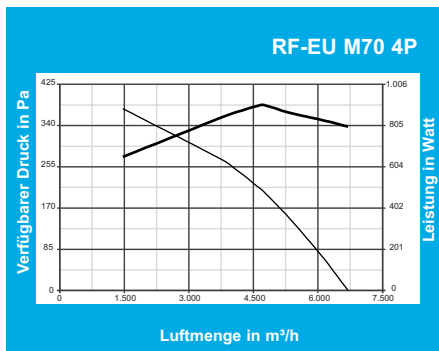
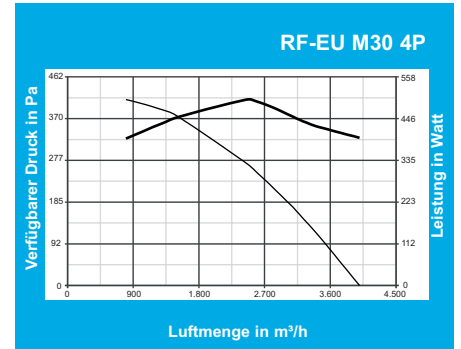
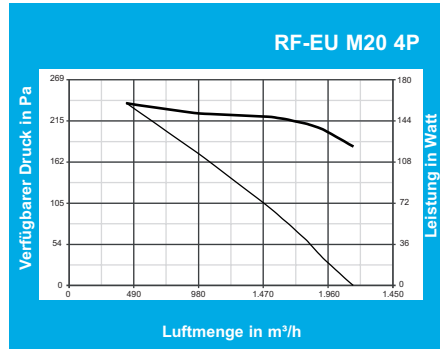
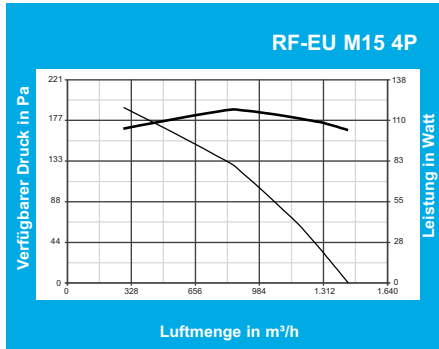

Dachventilatoren

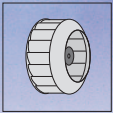

Leistungsdiagramme RF-EU

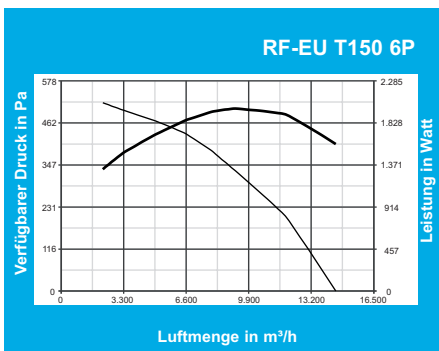
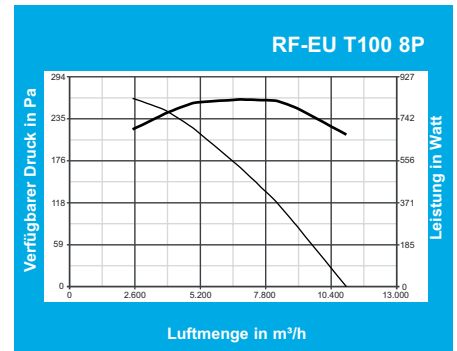
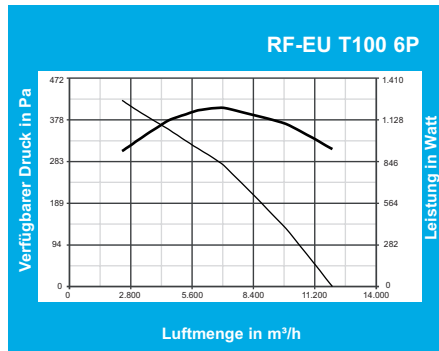
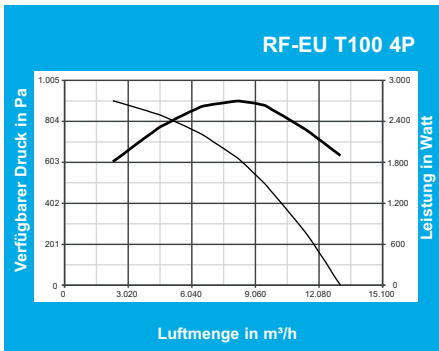
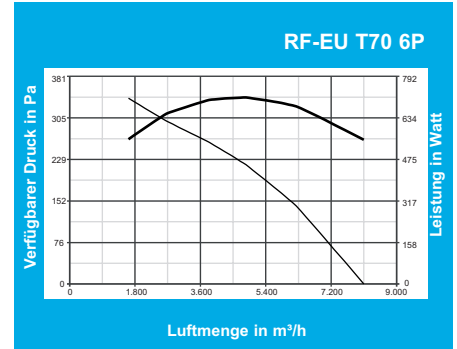
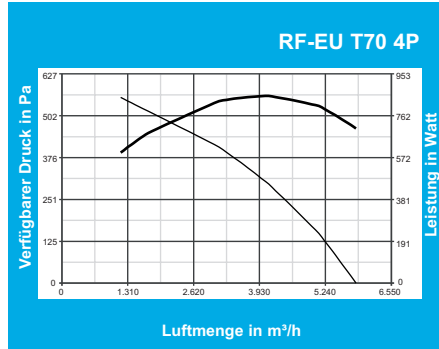
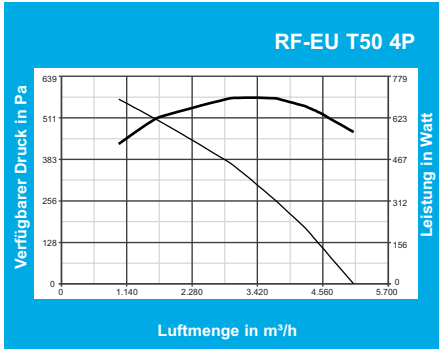

— Fördermenge — Leistungsaufnahme

