

Dachventilatoren

für gewerblichen und industriellen Einsatz



TRM..E und TRT..E



TRM..E-V und TRT..E-V

Serie TRM und TRT horizontal oder vertikal ausblasend

- Gehäuse aus verzinktem Stahlblech mit Epoxydharzlackierung
- selbstreinigendes, rückwärts gekrümmtes Aluminiumlaufrad mit Aluminiumdruckgussnabe
- Transportösen zum sicheren Transport an den Montageort
- strömungstechnisch optimierte Einströmdüse
- Motor mit thermischen Überlastungsschutz
- Schutzart IP55
- Drehstrommodelle mit 2-stufigem Motor, Stufenschaltung über optionalen Schalter
- zur sicheren Befestigung ist das Gerät mit einem Sicherheitsseil ausgestattet, das an der Tragekonstruktion befestigt werden kann
- Ausführungsformen:

TRM..E und **TRT..E** mit horizontaler Ausblasung

TRM..E-V und **TRT..E-V** mit vertikaler Ausblasung

Type TRM ...		10E 4P	15E 4P	20E 4P	30E 4P	50E 4P	70E 4P
Art. Nr.		15115	15205	15216	15356	15556	15070
Preis		459,40	482,40	633,10	686,30	799,70	1.612,30
Type TRM ...		10E-V 4P	15E-V 4P	20E-V 4P	30E-V 4P	50E-V 4P	70E-V 4P
Art. Nr.		15180	15182	15197	15198	15199	15188
Preis		634,60	627,40	822,60	891,60	999,20	2.014,30
Fördermenge	m³/h	1100	1400	2600	3300	4800	6400
max. Druck	Pa	216	255	353	432	540	662
Spannung 50 Hz	V	230	230	230	230	230	230
Nennstrom	A	0,50	0,70	1,30	1,80	3,70	4,35
Leistungsaufnahme	W	100	150	280	400	800	1000
Drehzahl	U/min	1400	1400	1415	1425	1480	1415
Schallpegel (3 m)	dB(A)	56	58,5	62	67	72,5	77
Fördertemperatur	°C	90	80	85	70	80	90

Type TRT ...		10E 4P	15E 4P	20E 4P	30E 4P	50E 4P	70E 4P	70E 6P
Art. Nr.		15155	15255	15215	15355	15555	15071	15072
Preis		466,60	476,60	594,40	653,20	739,40	1.550,50	1.661,10
Type TRT ...		10E-V 4P	15E-V 4P	20E-V 4P	30E-V 4P	50E-V 4P	70E-V 4P	70E-V 6P
Art. Nr.		15181	15183	15184	15185	15186	15187	15189
Preis		644,60	618,80	772,40	849,90	924,60	1.938,20	2.077,40
Fördermenge	m³/h	1100	1400	2700	3200	4900	6400	7000
max. Druck	Pa	216	255	343	451	598	674	373
Spannung 50 Hz	V	3x230 / 400	3x230 / 400	3x230 / 400	3x230 / 400	3x230 / 400	3x230 / 400	3x230 / 400
Nennstrom	A	0.30	0.30	0.60	0.75	1.45	1.85	1.30
Leistungsaufnahme	W	100	150	300	400	800	950	600
Drehzahl	U/min	1400	1400	1400	1400	1400	1440	950
Schallpegel (3 m)	dB(A)	56	58.5	62	67	72.5	77	74
Fördertemperatur	°C	90	90	90	90	90	90	90

Type TRT ...		100E 4P	100E 6P	100E 8P	150E 6P	150E 8P	180E 6P	210E 6P
Art. Nr.		15073	15074	15075	15076	15077	15078	15079
Preis		1615,10	2.132,00	2.350,20	2.307,10	2.582,80	2.710,60	2.900,10
Type TRT ...		100E-V 4P	100E-V 6P	100E-V 8P	150E-V 6P	150E-V 8P	180E-V 6P	210E-V 6P
Art. Nr.		15190	15191	15192	15193	15194	15195	15196
Preis		2018,60	2.664,60	2.937,40	2.882,90	3.228,90	3.251,80	3.480,10
Fördermenge	m³/h	10000	10800	11000	15000	15000	16000	18000
max. Druck	Pa	830	471	334	598	441	775	775
Spannung 50 Hz	V	3x230 / 400	3x230 / 400	3x230 / 400	3x230 / 400	3x230 / 400	3x230 / 400	3x230 / 400
Nennstrom	A	3.25	2.30	2.10	3.45	3.10	5.95	6.40
Leistungsaufnahme	W	1900	1100	930	1930	1600	3100	3400
Drehzahl	U/min	1420	950	715	930	715	970	980
Schallpegel (3 m)	dB(A)	84	77	71	80	74	83	84
Fördertemperatur	°C	70	85	80	80	75	80	70

Dachventilatoren

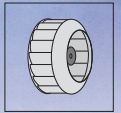

Abmessungen

TRM..E und TRT..E mit horizontaler Ausblasung

Abmessungen

Modell	ø A	□ B	□ C	D	E	F	G	H	ø L	ø M	ø N	kg
TRM 10 E 4P	600	410	357	310	108	36	26,5	456	170	187,5	283	14,5
TRM 15 E 4P	600	410	357	310	108	38	26,5	456	182	199	315	15
TRM 20 E 4P	780	550	500	398	128	38	25	564	219	236,5	359	22
TRM 30 E 4P	780	550	500	398	146	38	25	582	244	265,5	404	23
TRM 50 E 4P	780	550	500	398	173	38	25	609	278	298	454	28
TRM 70 E 4P	1015	830	750	449	283	38	40	770	328	395	504	79
TRT 10 E 4P	600	410	357	310	108	38	26,5	456	170	187,5	283	14,5
TRT 15 E 4P	600	410	357	310	108	38	26,5	456	182	199	315	15
TRT 20 E 4P	780	550	500	398	128	38	25	564	219	236,5	359	22
TRT 30 E 4P	780	550	500	398	146	38	25	582	244	265,5	404	23
TRT 50 E 4P	780	550	500	398	173	38	25	609	278	298	454	28
TRT 70 E 4P	1015	830	750	449	283	38	40	770	328	335	504	77
TRT 100 E 4P	1015	830	750	449	283	38	40	770	365	375	564	81
TRT 100 E 6P	1165	980	900	605	383	38	40	1026	415	421	635	117
TRT 100 E 8P	1165	980	900	605	383	38	40	1026	465	472	715	127
TRT 150 E 6P	1165	980	900	605	383	38	40	1026	465	472	715	128
TRT 150 E 8P	1165	980	900	605	383	38	40	1026	520	529	805	132
TRT 180 E 6P	1165	980	900	605	383	38	40	1026	520	529	805	130
TRT 210 E 6P	1165	980	900	605	383	38	40	1026	520	529	805	132

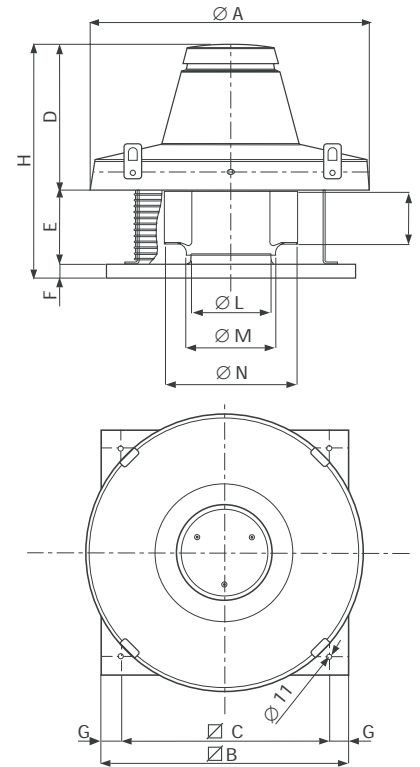

TRM..EV und TRT..EV mit vertikaler Ausblasung

Abmessungen

Modell	□ A	□ B	□ C	□ D	E	F	G	H	ø L	ø M	ø N	ø Q	kg
TRM 10 E-V 4P	652	410	357	440	328	38	26,5	502	170	187,5	283	11	23
TRM 15 E-V 4P	652	410	357	440	328	38	26,5	502	182	199	315	11	24
TRM 20 E-V 4P	907	550	500	580	432	38	25	586	219	236,5	359	11	43
TRM 30 E-V 4P	907	550	500	580	432	38	25	604	244	265,5	404	11	45
TRM 50 E-V 4P	907	550	500	580	432	38	25	631	278	298	454	11	51
TRM 70 E-V 4P	1144	830	750	860	491	38	40	723	328	335	504	12	105
TRT 10 E-V 4P	652	410	357	440	328	38	26,5	502	170	187,5	283	11	23
TRT 15 E-V 4P	652	410	357	440	328	38	26,5	502	182	199	315	11	24
TRT 20 E-V 4P	907	550	500	580	432	38	25	586	219	236,5	359	11	43
TRT 30 E-V 4P	907	550	500	580	432	38	25	604	244	265,5	404	11	45
TRT 50 E-V 4P	907	550	500	580	432	38	25	631	278	298	454	11	51
TRT 70 E-V 4P	1144	830	750	860	491	38	40	723	328	375	564	12	103
TRT 70 E-V 6P	1144	830	750	860	491	38	40	723	365	375	564	12	106
TRT 100 E-V 4P	1144	830	750	860	491	38	40	723	365	375	504	12	107
TRT 100 E-V 6P	1462	980	900	1010	595	38	40	903	415	421	635	12	161
TRT 100 E-V 8P	1462	980	900	1010	595	38	40	903	465	472	715	12	171
TRT 150 E-V 6P	1462	980	900	1010	595	38	40	903	465	472	715	12	172
TRT 150 E-V 8P	1462	980	900	1010	595	38	40	903	520	529	805	12	176
TRT 180 E-V 6P	1462	980	900	1010	595	38	40	903	520	529	805	12	174
TRT 210 E-V 6P	1462	980	900	1010	595	38	40	903	520	529	805	12	176

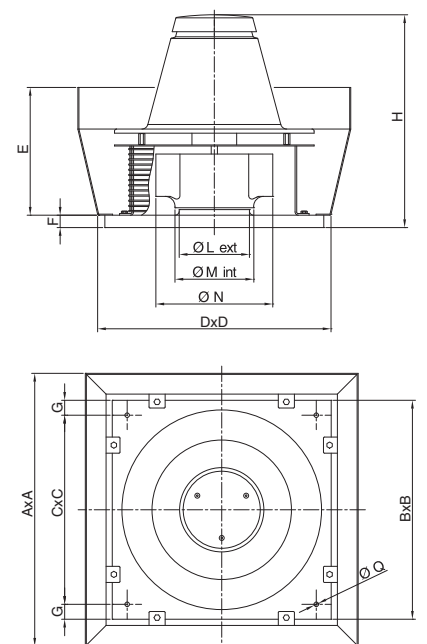

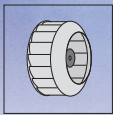

Dachventilatoren

Leistungsdiagramme

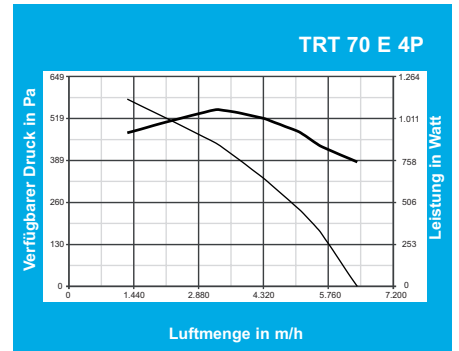
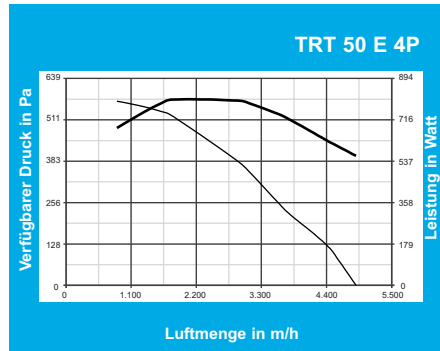
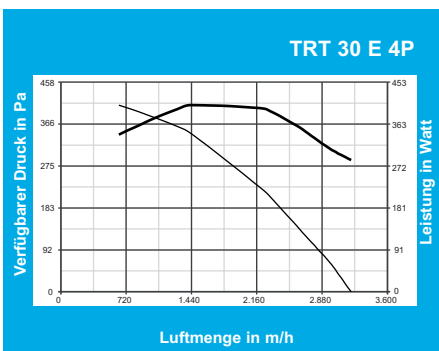
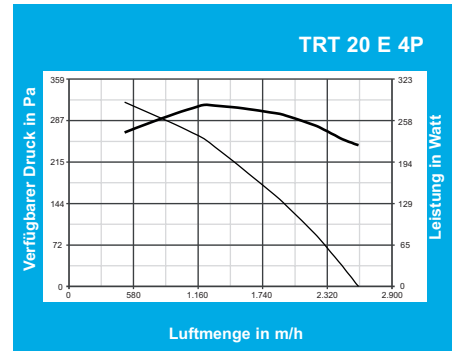
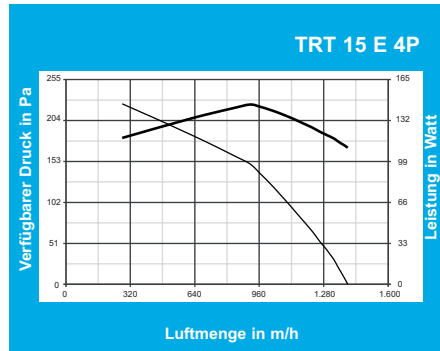
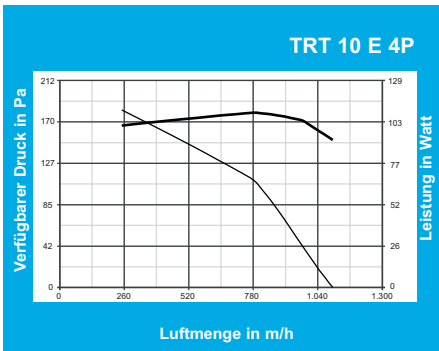
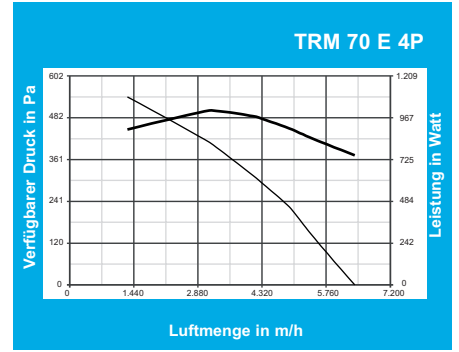
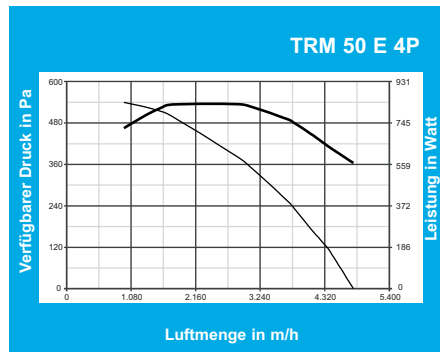
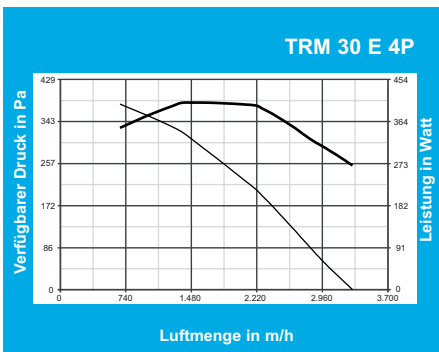
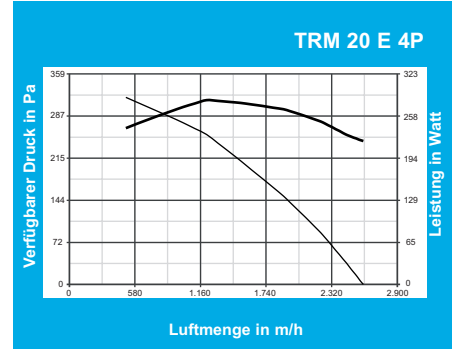
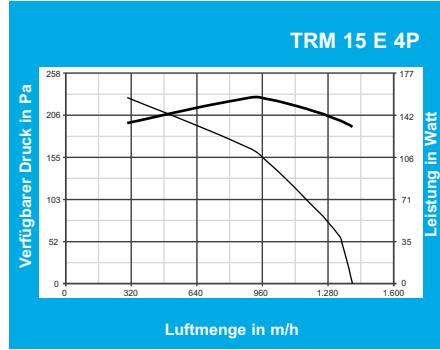
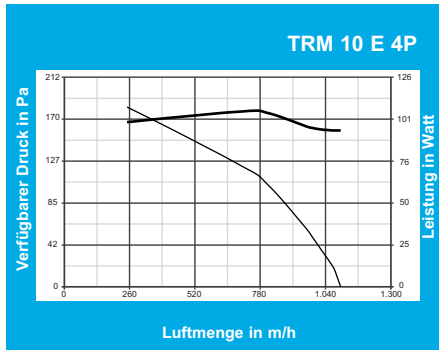

— Luftmenge
— Leistungsaufnahme

Dachventilatoren



für TRM...E, TRM...E-V, TRT...E und TRT...E-V

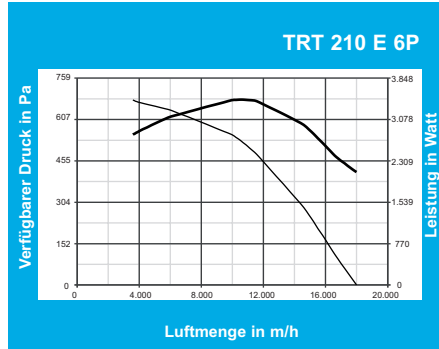
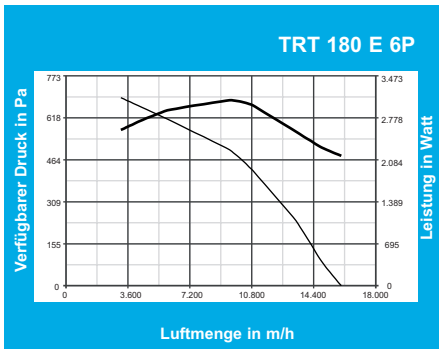
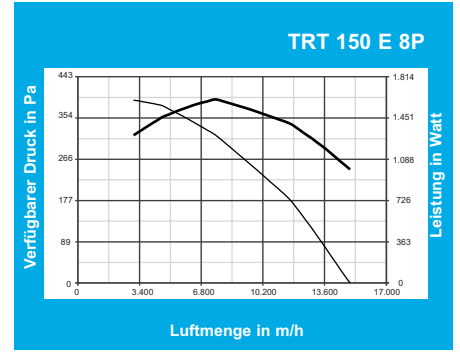
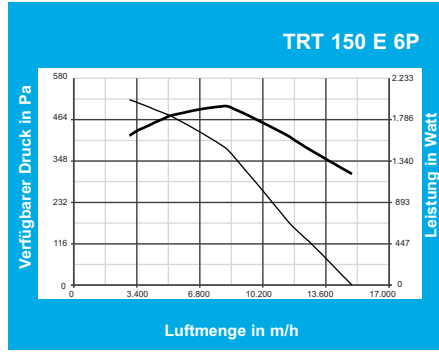
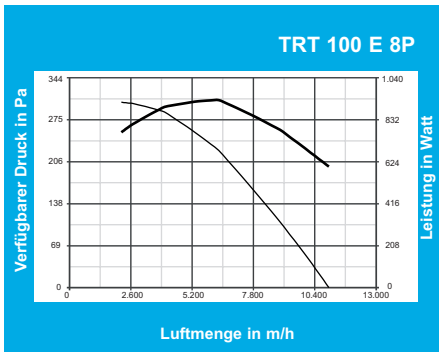
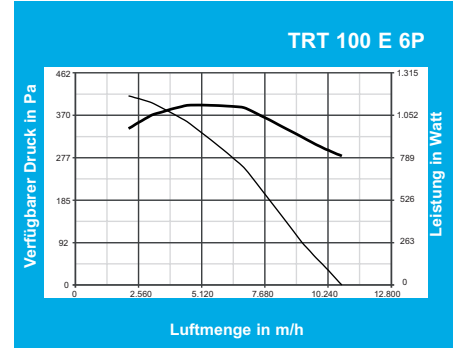
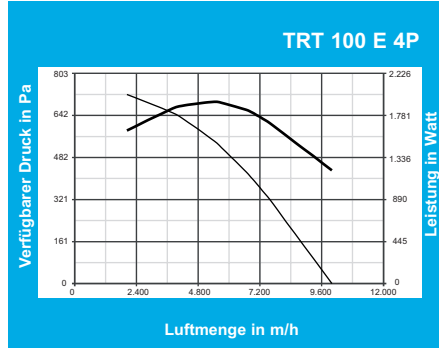
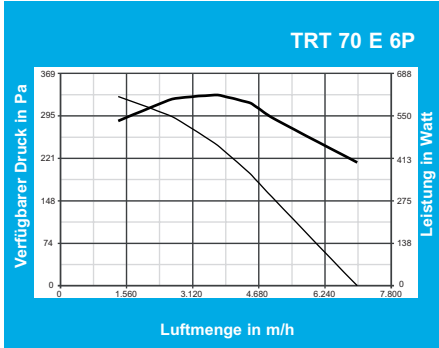

— Luftmenge
— Leistungsaufnahme

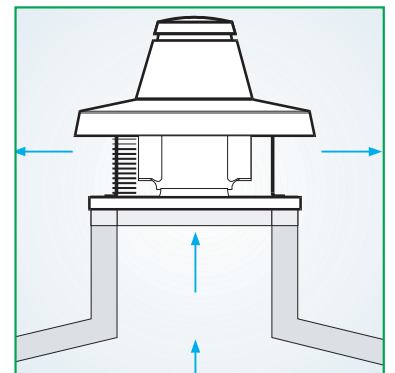
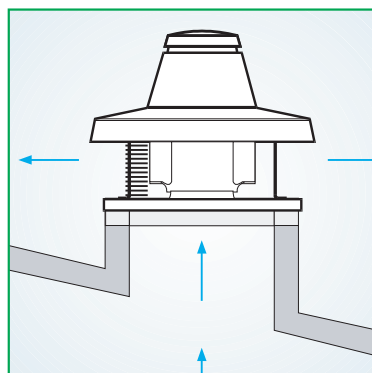
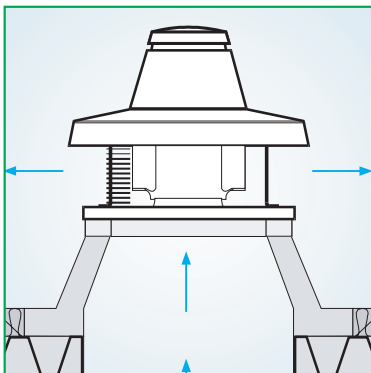

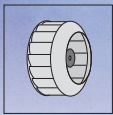









Dachventilatoren

Zubehör

für Serie TRM..E, TRM..E-V und TRT..E, TRT..E-V

Type	TRM 10 E 4P	TRT 10 E 4P	TRM 15 E 4P	TRT 15 E 4P	TRM 20 E 4P	TRT 20 E 4P	TRM 30 E 4P	TRT 30 E 4P	TRM 50 E 4P	TRT 50 E 4P
 Grundrahmen Art. Nr. Preis	TR-CU 10/15 22511 47,40	TR-CU 10/15 22511 47,40	TR-CU 10/15 22511 47,40	TR-CU 10/15 22511 47,40	TR-CU 20/30/50 22512 51,70	TR-CU 20/30/50 22512 51,70	TR-CU 20/30/50 22512 51,70	TR-CU 20/30/50 22512 51,70	TR-CU 20/30/50 22512 51,70	TR-CU 20/30/50 22512 51,70
 Schutzgitter saugseitig Art. Nr. Preis	TR-G 10/15 22700 14,40	TR-G 10/15 22700 14,40	TR-G 10/15 22700 14,40	TR-G 10/15 22700 14,40	TR-G 20/30/50 22710 20,10	TR-G 20/30/50 22710 20,10	TR-G 20/30/50 22710 20,10	TR-G 20/30/50 22710 20,10	TR-G 20/30/50 22710 20,10	TR-G 20/30/50 22710 20,10
 Rückschlagklappe Art. Nr. Preis	TR-S 10/15 22500 83,30	TR-S 10/15 22500 83,30	TR-S 10/15 22500 83,30	TR-S 10/15 22500 83,30	TR-S 20/30/50 22510 99,10	TR-S 20/30/50 22510 99,10	TR-S 20/30/50 22510 99,10	TR-S 20/30/50 22510 99,10	TR-S 20/30/50 22510 99,10	TR-S 20/30/50 22510 99,10
 Ansaugdüse Art. Nr. Preis	TR-B 10/15 22600 28,70	TR-B 10/15 22600 28,70	TR-B 10/15 22600 28,70	TR-B 10/15 22600 28,70	TR-B 20/30/50 22610 47,40	TR-B 20/30/50 22610 47,40	TR-B 20/30/50 22610 47,40	TR-B 20/30/50 22610 47,40	TR-B 20/30/50 22610 47,40	TR-B 20/30/50 22610 47,40
 Drehzahlregler 3-stufig 1-phasig, 230 V / 50 Hz Art. Nr. Preis	IRM30 12921 201,00	- - -	IRM30 12921 201,00	- - -	IRM40 12922 211,00	- - -	IRM40 12922 211,00	- - -	IRM50 12928 225,40	- - -
 Drehzahlregler 3-stufig 3-phasig, 3x400 V / 50 Hz Art. Nr. Preis	- -	IRT15 12923 244,10	- -	IRT15 12923 244,10	- -	IRT15 12923 244,10	- -	IRT35 12924 282,80	- -	IRT35 12924 282,80
 Drehzahlsteller 230V elektronisch stufenlos Art. Nr. Preis	IREM3 12931 196,70	- -	IREM3 12931 196,70	- -	IREM3 12931 196,70	- -	IREM3 12931 196,70	- -	IREM5 12932 239,80	- -
 Frequenzumformer* 3-phasig, 3x400 V / 50 Hz Art. Nr. Preis	- -	IRET INV2.5 12816 1.173,00	- -	IRET INV2.5 12816 1.173,00	- -	IRET INV2.5 12816 1.173,00	- -	IRET INV2.5 12816 1.173,00	- -	IRET INV2.5 12816 1.173,00

* auch als 230 V Version lieferbar (siehe Seite 235)

Ansaugdüse für TR..

	Art. Nr.	Preis	ØA	ØB	ØC
TR-B10/15	22600	28,70	225	254	275
TR-B20/30/50	22610	47,40	330	359	380
TR-B70/100	22508	188,10	430	500	480
TR-B100/150	22509	213,90	570	640	620

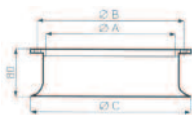

Grundrahmen für TR.. und TR..ED

	Art. Nr.	Preis	A	B
TR-CU 10/15	22511	47,40	357	401
TR-CU20/30/50	22512	51,70	500	541
TR-CU70/100	22539	57,40	750	791
TR-CU100/150	22540	63,20	900	941

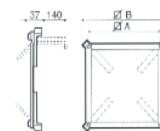

Schutzgitter für TR.. und TR..ED Saugseitig

	Art. Nr.	Preis	ØA	ØB
TR-G10/15	22700	14,40	222	254
TR-G20/30/50	22710	20,10	318	359
TR-G70/100	22506	51,70	423	500
TR-G100/150	22507	64,60	563	640

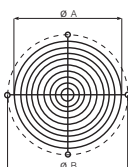

Rückschlagklappe für TR.. und TR..ED

	Art. Nr.	Preis	ØA	ØB	ØC	H
TR-S10/15	22500	83,30	225	254	275	210
TR-S20/30/50	22510	99,10	330	359	380	210
TR-S70/100	22541	310,10	430	500	520	260
TR-S100/150	22542	456,50	570	640	660	330

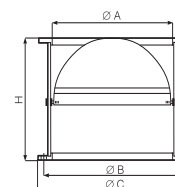

Dachventilatoren

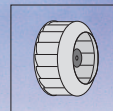

Zubehör

für Serie TRM..E, TRM..E-V und TRT..E, TRT..E-V

Type	TRM 70 E 4P	TRT 70 E 4P	TRT 70 E 6P	TRT 100 E 4P	TRT 100 E 6P	TRT 100 E 8P	TRT 150 E 6P	TRT 150 E 8P	TRT 180 E 6P	TRT 210 E 6P
Grundrahmen Art. Nr. Preis	TR-CU 70/100 22539 57,40	TR-CU 70/100 22539 57,40	TR-CU 70/100 22539 57,40	TR-CU 70/100 22539 57,40	TR-CU 100/150 22540 63,20	TR-CU 100/150 22540 63,20	TR-CU 100/150 22540 63,20	TR-CU 100/150 22540 63,20	TR-CU 100/150 22540 63,20	TR-CU 100/150 22540 63,20
Schutzgitter saugseitig 70/100 Art. Nr. Preis	TR-G 70/100 22506 51,70	TR-G 70/100 22506 51,70	TR-G 70/100 22506 51,70	TR-G 70/100 22506 51,70	TR-G 100/150 22507 64,60	TR-G 100/150 22507 64,60	TR-G 100/150 22507 64,60	TR-G 100/150 22507 64,60	TR-G 100/150 22507 64,60	TR-G 100/150 22507 64,60
Rückschlagklappe Art. Nr. Preis	TR-S 70/100 22541 310,10	TR-S 70/100 22541 310,10	TR-S 70/100 22541 310,10	TR-S 70/100 22541 310,10	TR-S 100/150 22542 456,50	TR-S 100/150 22542 456,50	TR-S 100/150 22542 456,50	TR-S 100/150 22542 456,50	TR-S 100/150 22542 456,50	TR-S 100/150 22542 456,50
Ansaugdüse Art. Nr. Preis	TR-B 70/100 22508 188,10	TR-B 70/100 22508 188,10	TR-B 70/100 22508 188,10	TR-B 70/100 22508 188,10	TR-B 100/150 22509 213,90	TR-B 100/150 22509 213,90	TR-B 100/150 22509 213,90	TR-B 100/150 22509 213,90	TR-B 100/150 22509 213,90	TR-B 100/150 22509 213,90
Drehzahlregler 3-stufig 1-phasig, 230 V / 50 Hz Art. Nr. Preis	- - -	- - -	- - -	- - -	- - -	- - -	- - -	- - -	- - -	- - -
Drehzahlregler 3-stufig 3-phasig, 3x400 V / 50 Hz Art. Nr. Preis	- - -	IRT40 12927 387,60	IRT35 12924 282,80	IRT40 12927 387,60	IRT40 12927 387,60	IRT35 12924 282,80	IRT35 12924 282,80	IRT35 12924 282,80	IRT40 12927 387,60	- - -
Drehzahlsteller 230V elektronisch stufenlos Art. Nr. Preis	IREM5 12932 239,80	IRET6 12934 704,90	IRET6 12934 704,90	IRET6 12934 704,90	IRET6 12934 704,90	IRET6 12934 704,90	IRET6 12934 704,90	IRET6 12934 704,90	- - -	- - -
Frequenzumformer 3-phasig, 3x400 V / 50 Hz Art. Nr. Preis	- - -	IRET INV2.5 12816 1.173,00	IRET INV2.5 12816 1.173,00	IRET INV8 12821 1.775,90	IRET INV5 12817 1.625,20	IRET INV2.5 12816 1.173,00	IRET INV5 12817 1.625,20	IRET INV5 12817 1.625,20	IRET INV8 12821 1.775,90	IRET INV8 12821 1.775,90

Drehzahlregler stufenlos

IREM. für 230 V/50 Hz, IRET. für 3 x 400 V/50 Hz

	Art. Nr.	Preis	A	B	C	D	E
IREM 3	12931	196,70	125	57	31	25	88
IREM 5	12932	239,80	125	57	31	25	88
IREM 9	12933	336,00	125	72	31	25	103
IRET 6	12934	704,90	175	78	27	30	108

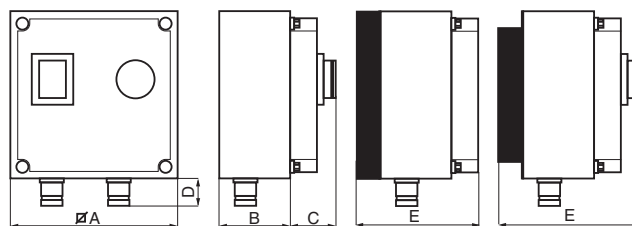

Drehzahlregler 3-stufig

IRM.. für 230 V/50 Hz, IRT.. für 3 x 400 V/50 Hz

	Art. Nr.	Preis	A	B	C	D
IRM 30	12921	201,00	200	254	99	128
IRM 40	12922	211,00	236	315	128	157
IRM 50	12928	225,40	236	315	128	157
IRT 15	12923	244,10	236	315	128	157
IRT 35	12924	282,80	236	315	128	157
IRT 40	12927	387,60	236	315	128	157

Frequenzumformer

IRET.. für 3 x 400 V/50 Hz

	Art. Nr.	Preis	A	B	C
IRET INV2.5	12816	1.173,00	115	284	240
IRET INV5	12817	1.625,20	196	302	250
IRET INV8	12821	1.775,90	196	302	250

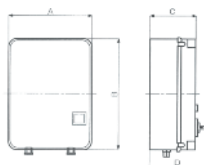

Potentiometer zu Frequenzumformer POT zu Serie IRET INV...

	Art. Nr.	Preis (RG: VF)
POT	12828	78,20

